

SPECIFIKUS MONORACK

HONDA CB600F 2003 HORNET

SZERELÉSI ÚTMUTATÓ

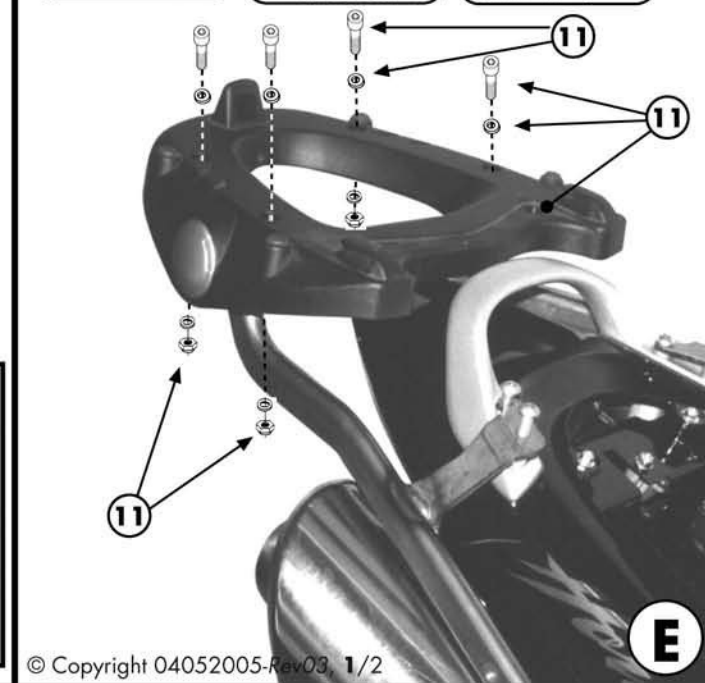
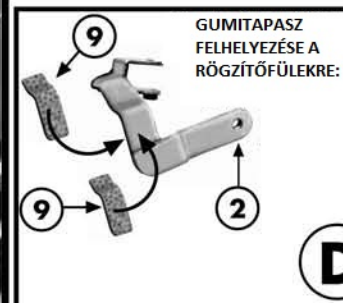
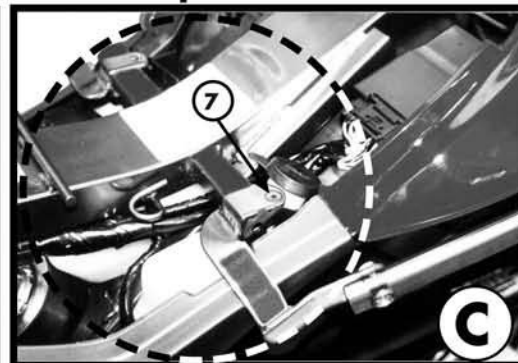
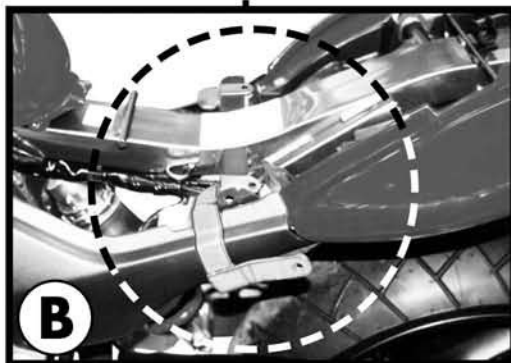
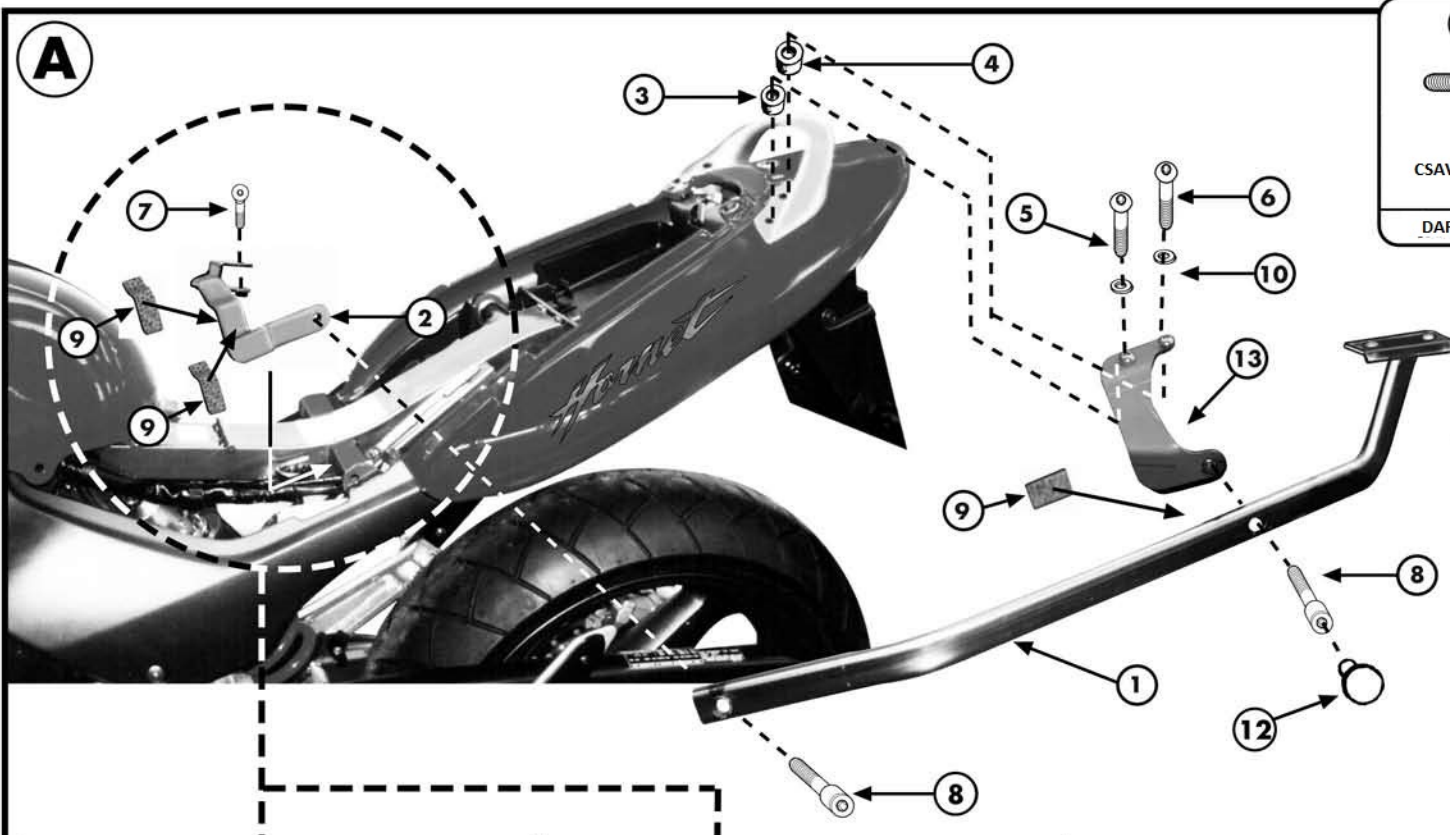
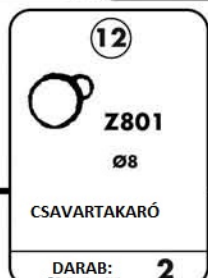
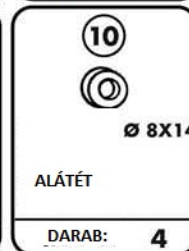
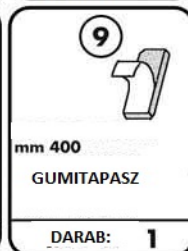
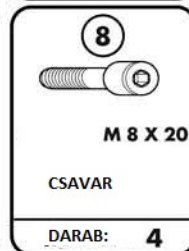
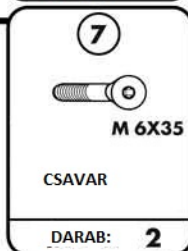
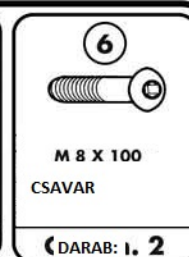
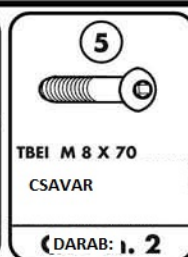
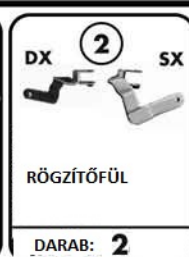
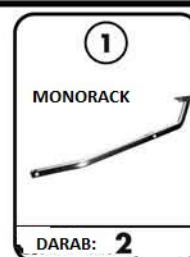

SPECIÁLIS MONORACK

HONDA CB600F 2003 HORNET

SZERELÉSI ÚTMUTATÓ

H

FELHELYEZÉSI ÚTMUTATÓ

1. NE FELEJTSE EL FELHELYEZNI A "9" GUMITAPASZT A "2" RÖGZÍTŐFÜLEKRE AHOGY A "D" ÁBRÁNAK MEGFELELŐEN
2. A "2" RÖGZÍTŐFÜLEKET AZ "A", "B", ILLETVE A "C" ÁBRÁK ALAPJÁN
3. AZ "1" ÁBRÁNAK MEGFELELŐEN A MONORACK KAROKRA IS HELYEZZEN FEL "9" GUMITAPASZT
4. MAJD AZ "A" ÁBRÁNAK MEGFELELŐEN RÖGZÍTSE A MONORACK KAROKAT
5. FOLYTASSA A PLATNI FELHELYEZÉSÉVEL AZ "E" ÁBRÁNAK MEGFELELŐEN
6. VÉGÜL ELLENŐRÍZZE AZ ÖSSZES CSAVART ÉS HÚZZA MEG AZOKAT

E MOUNTING INSTRUCTIONS

1. PAY ATTENTION TO PLACE THE PROTECTIVE ADHESIVE RUBBERS N°9 ON THE SUPPORTS N° 2 AS SHOWN IN PICTURE A AND D.
2. MOUNT THE SUPPORTS N°2 AS SHOWN IN PICTURE A, B AND C.
3. FIX THE ADHESIVE RUBBERS N°9 TO THE SUPPORT (SIDE ARM) N°1 AS SHOWN IN PICTURE A.
4. NOW MOUNT THE SUPPORT (SIDE ARM) N°1 AS SHOWN IN PICTURE A.
5. PROCEED WITH THE MOUNTING OF THE PLATE AS SHOWN IN PICTURE E.
6. LASTLY TIGHTEN ALL THE SCREWS.

F INSTRUCTIONS DE MONTAGE

1. FAIRE ATTENTION A BIEN POSITIONNER LES MOUSSES DE PROTECTION N°9 SUR LES SUPPORTS N°2 COMME INDIQUE SUR LES PHOTOS A ET D.
2. MONTER LES SUPPORTS N°2 COMME INDIQUE SUR LES PHOTOS A, B ET C.
3. FIXER LA MOUSSE N°9 SUR LES BRAS N°1 COMME INDIQUE SUR LA PHOTO A.
4. MONTER LES BRAS N°1 COMME INDIQUE SUR LA PHOTO A.
5. PROCEDER AU MONTAGE DE LA PLATINE COMME MONTRE SUR LA PHOTO E.
6. FINIR LE MONTAGE EN SERRANT BIEN TOUTES LES VIS.

D BAUANLEITUNG

1. KLEBEN SIE DAS MOOSGUMMISTÜCK NR. 9 AM UNTEREN TEIL DES HALTERS NR. 2. WIE IM BILD A UND D BESCHRIEBEN
2. MONTIEREN SIE DIE HALTER NR. 2 WIE IM BILD A, B UND C BESCHRIEBEN.
3. JETZT KLEBEN SIE DAS MOOSGUMMISTÜCK NR. 9 AM OBEREN TEIL DES HALTERS NR. 2 WIE IM BILD A UND D BESCHRIEBEN.
4. MONTIEREN SIE DIE HALTER NR. 1 WIE IM BILD E BESCHRIEBEN.
5. MONTIEREN SIE DIE PLATTE WEITER, WIE IM BILD E BESCHRIEBEN.
6. ZULETZT ZIEHEN SIE ALLE SCHRAUBEN FEST.

ES

INSTRUCCIONES DE MONTAJE

1. POSICIONAR LAS ESPUMAS ADHESIVAS NR 9 SOBRE LOS SOPORTES NR 2 COMO INDICAN LAS FOTO A E D
2. MONTAR LOS SOPORTES NR 2 COMO INDICAN LAS FOTOS A, B Y C
3. PEGAR LAS ESPUMAS ADHESIVAS NR 9 A LOS SOPORTES NR 1 COMO INDICA LA FOTO A
4. MONTAR LOS SOPORTES NR 1 COMO INDICA LA FOTO A
5. MONTAR LA PARRILLA COMO INDICA LA FOTO E
6. ACABAR APRETANDO TODOS LOS TORNILLOS