

MONORACK SPECIFICO - SPECIFIC MONORACK
 MONORACK SPECIFIQUE - SPEZIFISCHES MONORACK - MONORACK ESPECÍFICO

KAWASAKI Z750/Z1000 '07

ISTRUZIONI DI MONTAGGIO - MOUNTING INSTRUCTIONS
 INSTRUCTIONS DE MONTAGE - BAUANLEITUNG - INSTRUCCIONES DE MONTAJE

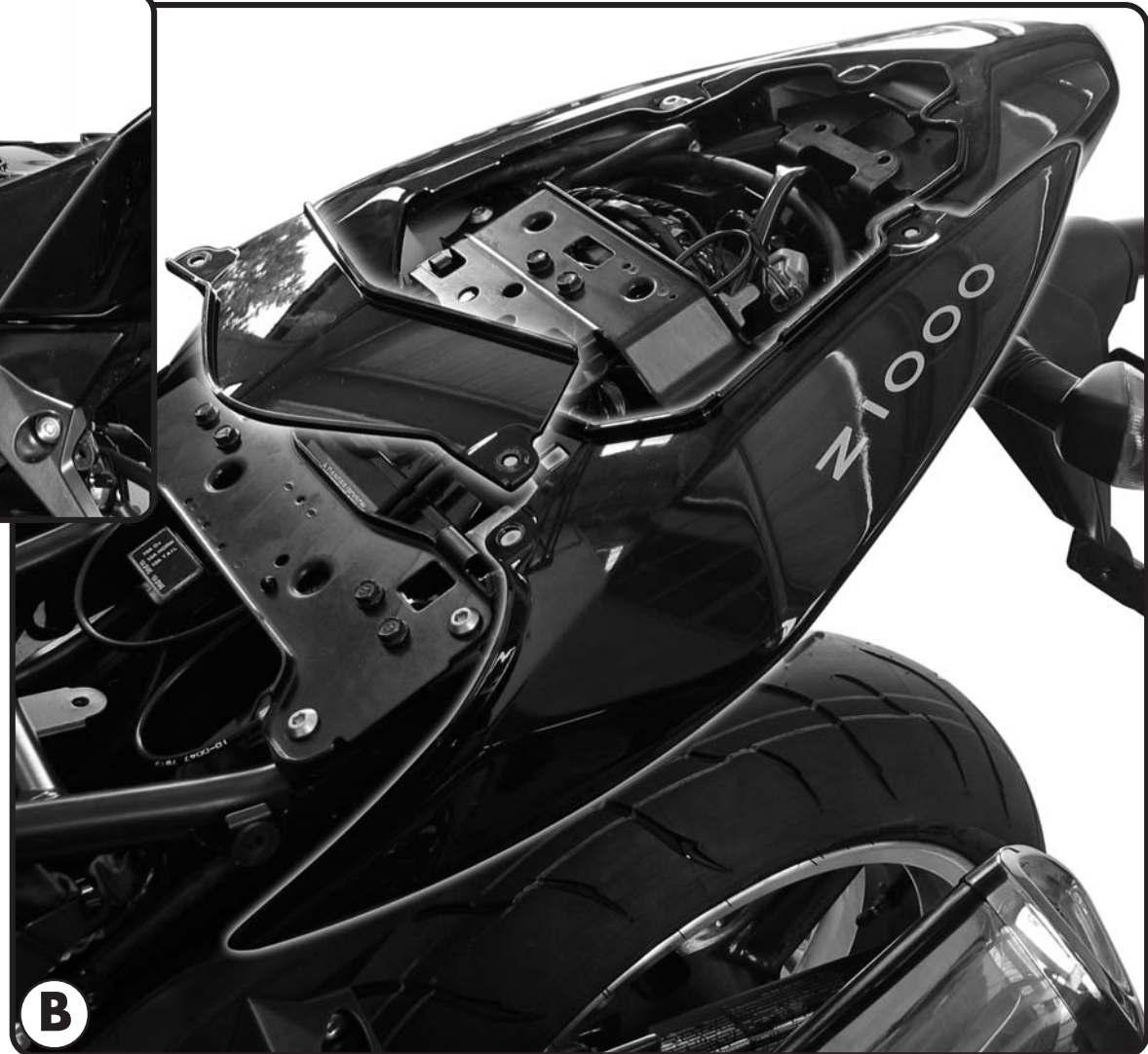
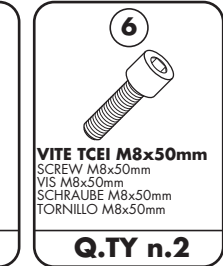
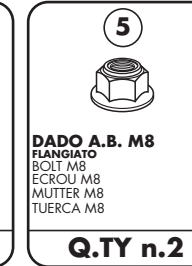
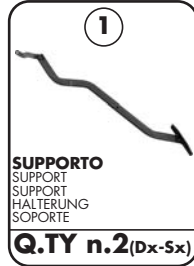

ATTENZIONE

PESO MASSIMO SOPPORTABILE 6Kg.

WARNING

MAX. LOADING 6Kg.(13lbs)

ATTENTION

CHARGE MAXIMALE 6Kg.

ACHTUNG

MAXIMALE BELASTUNG 6Kg.

¡ATENCIÓN!

CARGA MÁXIMA AUTORIZADA 6Kg.

448FZ - KZ448

MONORACK SPECIFICO - SPECIFIC MONORACK
MONORACK SPECIFIQUE - SPEZIFISCHES MONORACK - MONORACK ESPECÍFICO

KAWASAKI Z750/Z1000 '07

ISTRUZIONI DI MONTAGGIO - MOUNTING INSTRUCTIONS
INSTRUCTIONS DE MONTAGE - BAUANLEITUNG - INSTRUCCIONES DE MONTAJE

7



COPRIVITE Ø8mm
Z801
SCREW CAP
CACHE VIS
STOPSSCHRAUBE
TAPA TORNILLO

Q.TY n.2

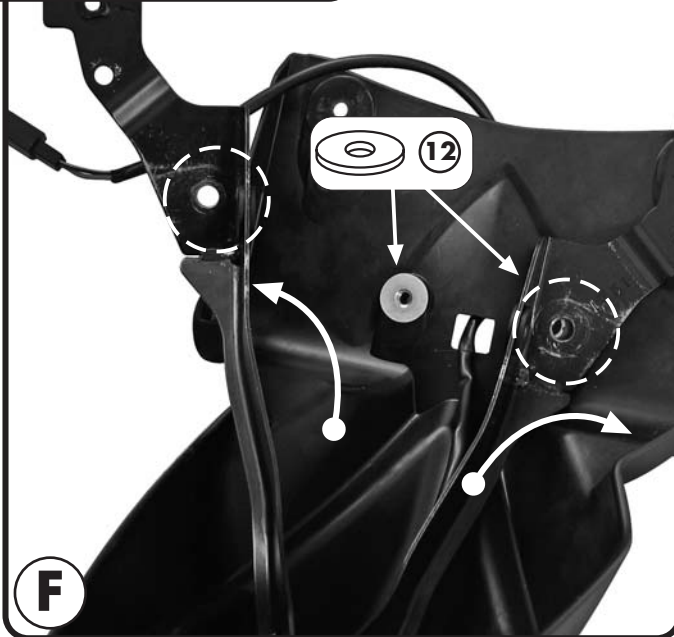
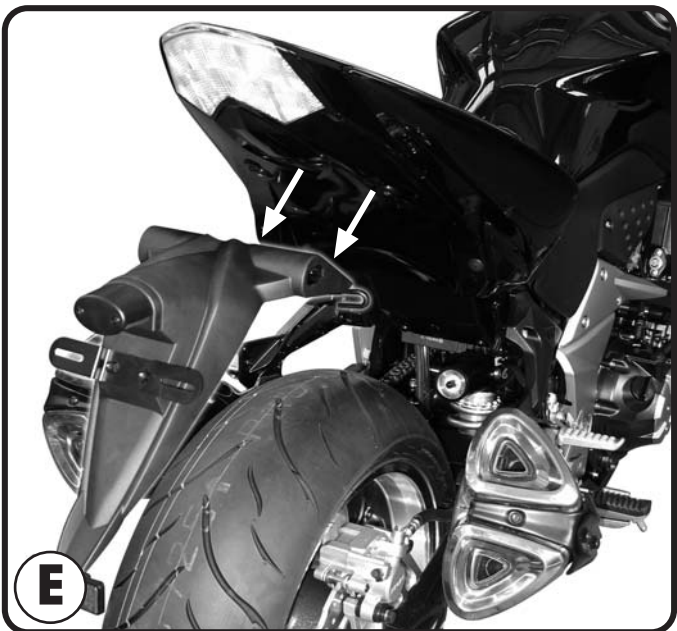
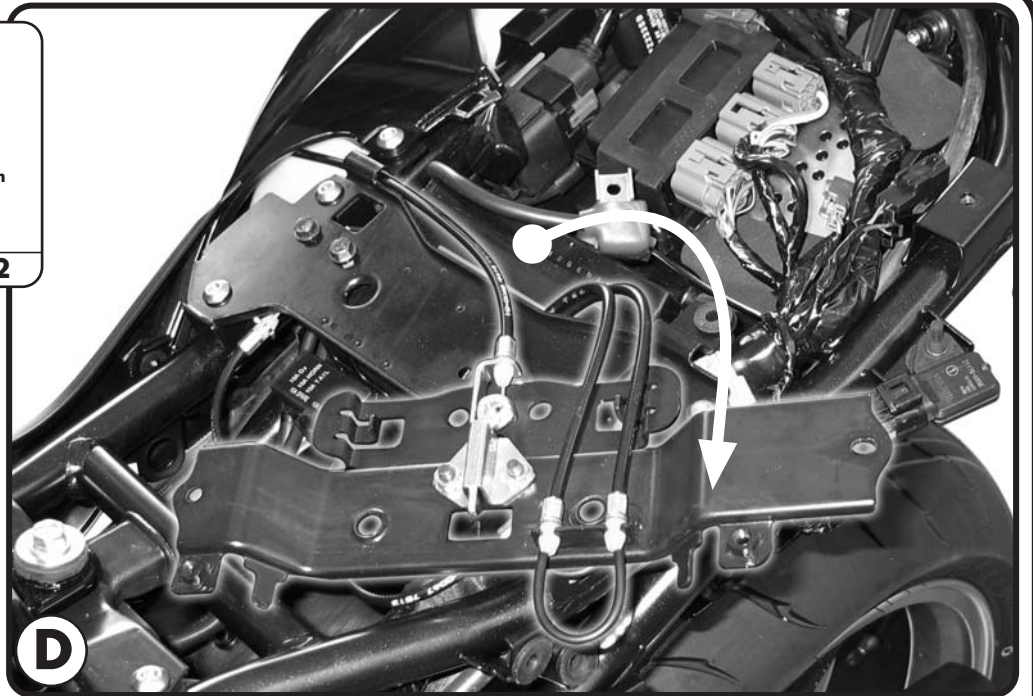
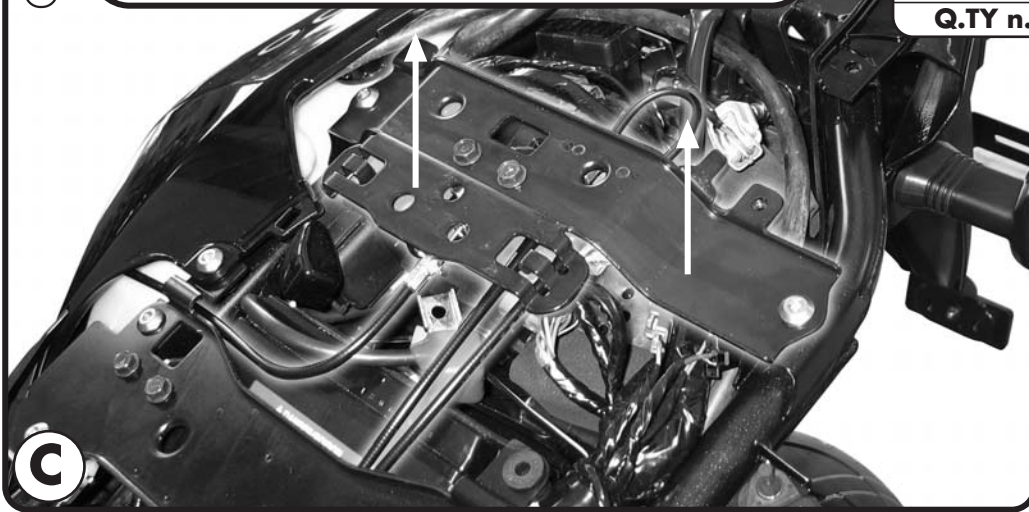

448FZ - KZ448

MONORACK SPECIFICO - SPECIFIC MONORACK
MONORACK SPECIFIQUE - SPEZIFISCHES MONORACK - MONORACK ESPECÍFICO

KAWASAKI Z750/Z1000 '07

ISTRUZIONI DI MONTAGGIO - MOUNTING INSTRUCTIONS
INSTRUCTIONS DE MONTAGE - BAUANLEITUNG - INSTRUCCIONES DE MONTAJE

8



VITE TEF M6x20mm
SCREW M6x20mm
VIS M6x20mm
SCHRAUBE M6x20mm
TORNILLO M6x20mm

Q.TY n.2

H

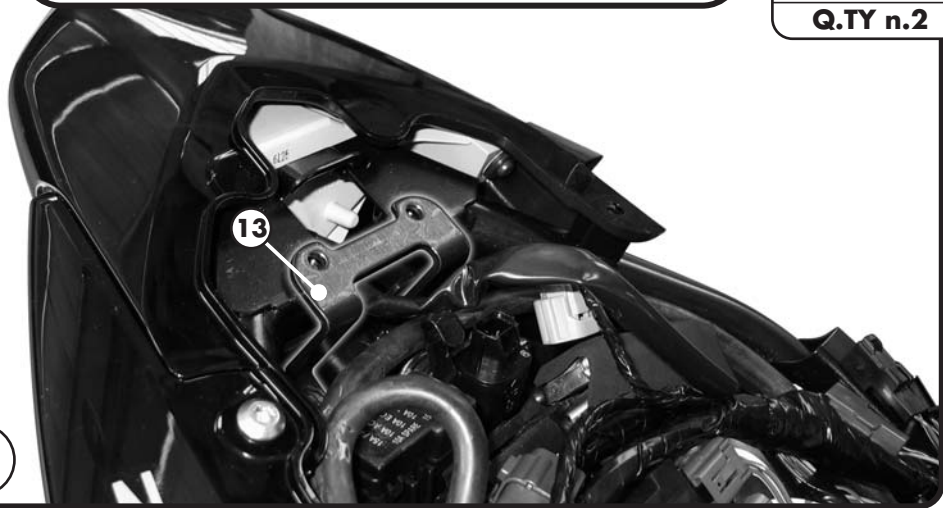

13

I

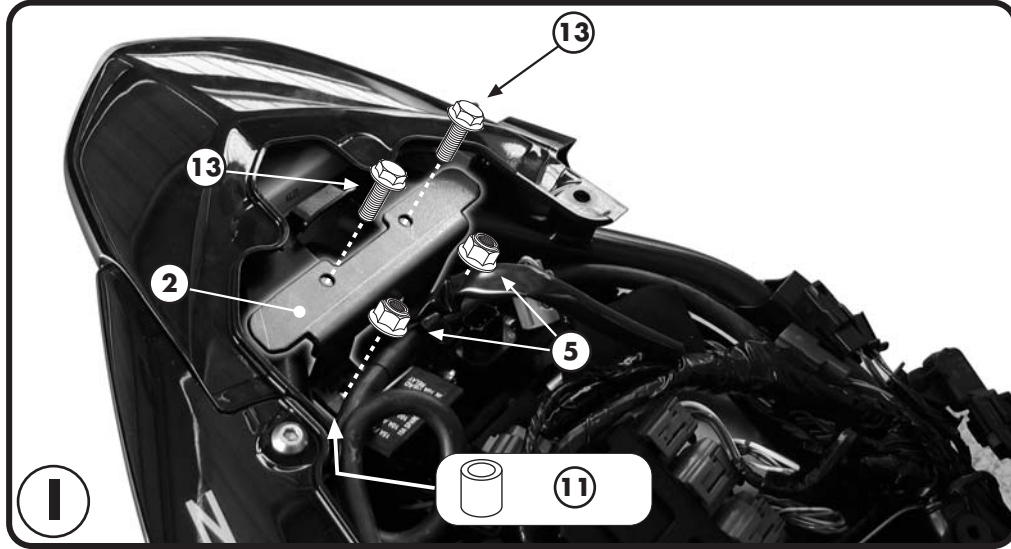

2

11

13

9



DADO A.B. M6
FLANGIATO
BOLT M6
ECROU M6
MUTTER M6
TUERCA M6

Q.TY n.1

10



DISTANZIALE Ø16x25mm
Foro Ø8,5mm, V383
SPACER
ENTRETOISE
Distanzstück
Distançador

Q.TY n.2

11



DISTANZIALE Ø12x18mm
Foro Ø8,5mm, V296
SPACER
ENTRETOISE
Distanzstück
Distançador

Q.TY n.2

M



3

L



3

4

MONORACK SPECIFICO - SPECIFIC MONORACK
MONORACK SPECIFIQUE - SPEZIFISCHES MONORACK - MONORACK ESPECÍFICO

KAWASAKI Z750/Z1000 '07

ISTRUZIONI DI MONTAGGIO - MOUNTING INSTRUCTIONS
INSTRUCTIONS DE MONTAGE - BAUANLEITUNG - INSTRUCCIONES DE MONTAJE

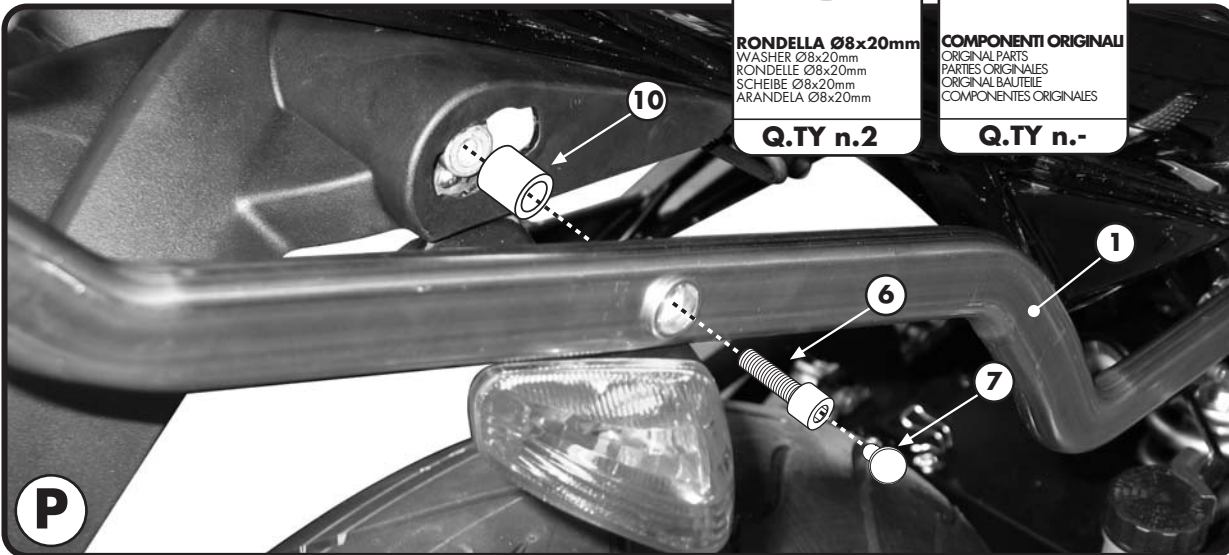
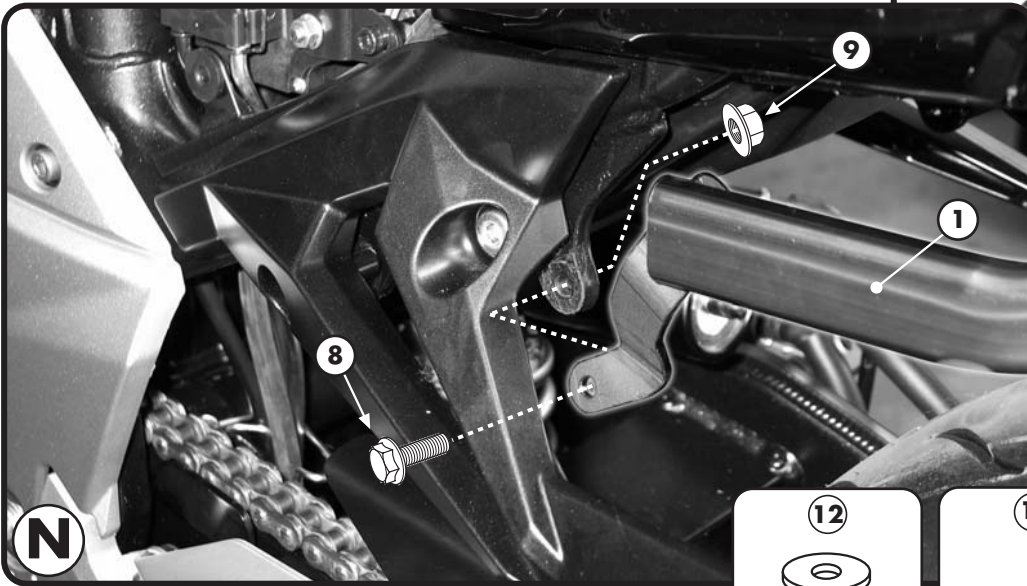

12

RONDELLA Ø8x20mm
WASHER Ø8x20mm
RONDELLE Ø8x20mm
SCHEIBE Ø8x20mm
ARANDELA Ø8x20mm

Q.TY n.2

13

COMPONENTI ORIGINALI
ORIGINAL PARTS
PARTIES ORIGINALES
ORIGINAL BAUTEILE
COMPONENTES ORIGINALES

Q.TY n.-

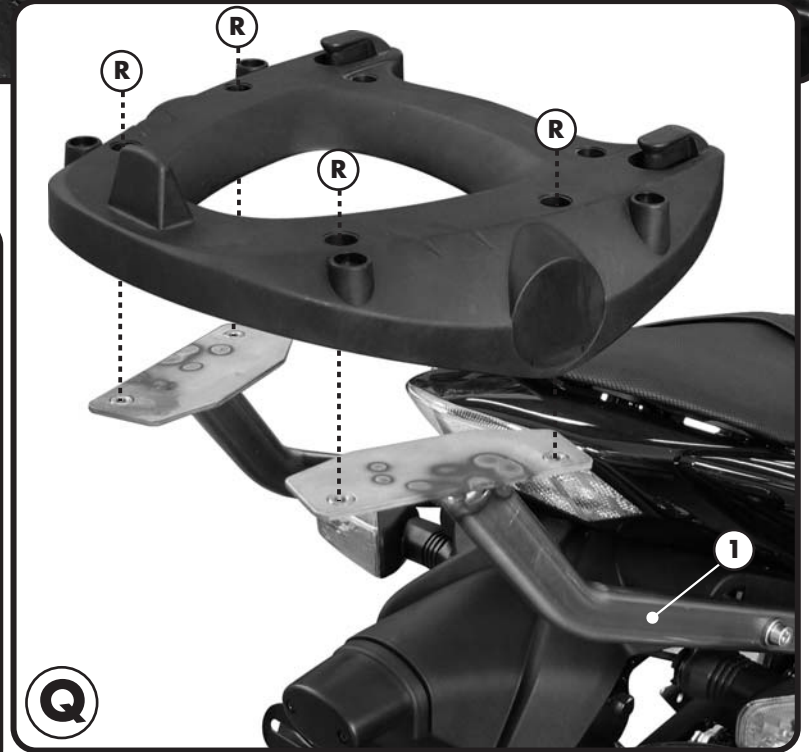
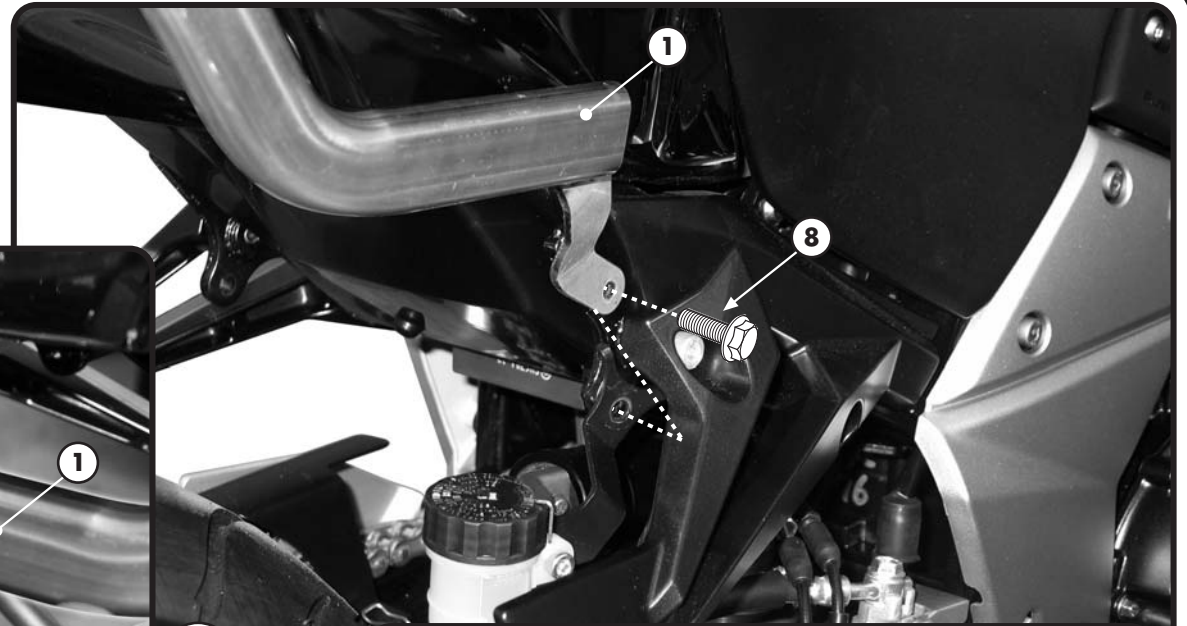

MONORACK SPECIFICO - SPECIFIC MONORACK
 MONORACK SPECIFIQUE - SPEZIFISCHES MONORACK - MONORACK ESPECÍFICO

KAWASAKI Z750/Z1000 '07

ISTRUZIONI DI MONTAGGIO - MOUNTING INSTRUCTIONS
 INSTRUCTIONS DE MONTAGE - BAUANLEITUNG - INSTRUCCIONES DE MONTAJE

14

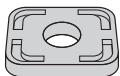

GOMMINO
 Z1822
 RUBBER
 CAOUTCHOUC
 GUMMI
 GOMA

Q.TY n.4

15



RONDELLA IN GOMMA
 Z1823
 RUBBER WASHER
 RONDELLE EN GOMME
 GUMMISCHIBE
 ARANDELA DE GOMA

Q.TY n.4

16



DISTANZIALE Ø11x11mm
 foro Ø6,5mm
 V687
 SPACER
 ENTRETÈISE
 DISTANZSTÜCK
 DISTANCIADOR

Q.TY n. 4

17

PARTICOLARI INCLUSI NEL KIT VITERIA DELLA PIASTRA
 COMPONENTS INCLUDED IN THE FITTING KIT OF THE PLATE
 PIÈCES INCLUES DANS LE KIT DE VIS DE LA PLATINE
 DIE EINZELNEN TEILE SIND BEI MONTAGEKIT DER PLATTE ENTHALTEN
 DESPIECES INCLUIDOS EN EL KIT DE ANCLAJES DE LA PARRILLA

Q.TY n.-

18



VITE TCEI M6x35mm
 SCREW
 VIS
 SCHRAUBE
 TORNILLO

Q.TY n.4

19



RONDELLA Ø6x20mm
 WASHER
 RONDELLE
 SCHEIBE
 ARANDELA

Q.TY n.4

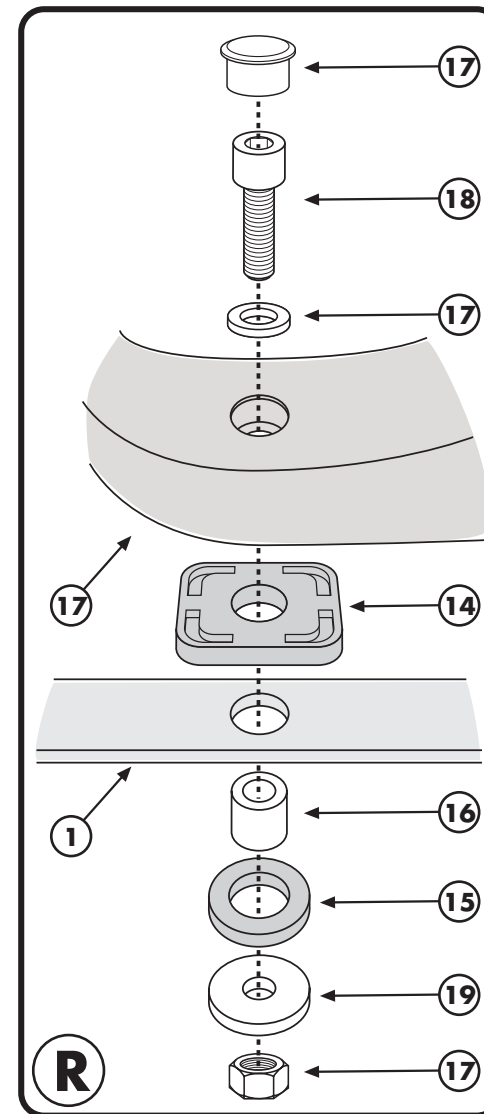

MONORACK SPECIFICO - SPECIFIC MONORACK
MONORACK SPECIFIQUE - SPEZIFISCHES MONORACK - MONORACK ESPECÍFICO

KAWASAKI Z750/Z1000 '07

ISTRUZIONI DI MONTAGGIO - MOUNTING INSTRUCTIONS
 INSTRUCTIONS DE MONTAGE - BAUANLEITUNG - INSTRUCCIONES DE MONTAJE

I ISTRUZIONI DI MONTAGGIO

1. SMONTARE LE PARTI DI CARENATURA INDICATE NELLE FOTOGRAFIE A e B; SMONTARE E POSIZIONARE COME INDICATO IN FOTOGRAFIA C e D IL SUPPORTO SOTTO SELLA EVIDENZIATO PER FACILITARE I MONTAGGI SUCCESSIVI;
2. SMONTARE IL PARAFANGO POSTERIORE, FOTOGRAFIA E; APOGGIARLO CAPOVOLTO SU DI UN PIANO, TOGLIERE LE BOCCOLE/RONDELLE ORIGINALI E ALLARGARE I FORI EVIDENZIATI NEI SUPPORTI IN FERRO DEL PARAFANGO, FOTOGRAFIA F, CON UNA PUNTA DEL TRAPANO DA Ø8,5mm; POI POSIZIONARE LE RONDELLE, PARTICOLARE 12, COME INDICATO IN FOTOGRAFIA F AL POSTO DELLE BOCCOLE/RONDELLE ORIGINALI CHE AVETE PRECEDENTEMENTE TOLTO;
3. POSIZIONARE COME INDICATO IN FOTOGRAFIA G IL SUPPORTO N°3; SOSTITUIRE IL SUPPORTO ORIGINALE INDICATO IN FOTOGRAFIA H CON IL SUPPORTO N°2, FOTOGRAFIA I, FACENDO ATTENZIONE A SOSTITUIRE ANCHE LE BOCCOLE FILETTATE POSTE SOTTO AL SUPPORTO ORIGINALE CHE AVETE SMONTATO CON QUELLE INDICATE IN FOTOGRAFIA I (PARTICOLARE 11);
4. RIMONTARE IL PARAFANGO COME INDICATO IN FOTOGRAFIA L; RIMONTARE LE FRECCIE ORIGINALI NEL SUPPORTO INDICATO IN FOTOGRAFIA M;
5. MONTARE I SUPPORTI MONORACK, PARTICOLARI 1, COME INDICATO NELLE FOTOGRAFIE N, O e P; MONTARE LA PIASTRA PORTAVALIGIA (NON INCLUSA) SEGUENDO LE ISTRUZIONI INCLUSE NELLA STESSA;
6. ULTIMARE IL MONTAGGIO CONTROLLANDO CHE TUTTE LE VITI SIANO SERRATE BENE.

GB MOUNTING INSTRUCTIONS

1. DISASSEMBLE FAIRING'S PIECES AS SHOWN IN PICTURES A AND B; DISASSEMBLE AND SET (AS YOU CAN SEE IN PICTURE C AND D) THE SUPPORT UNDER THE SADDLE MARKED IN ORDER TO MAKE EASIER THE FOLLOWING MOUNTINGS;
2. REMOVE THE REAR MUDGUARD, PICTURE E; REST IT UPTURNED ON A SURFACE, TAKE OUT THE ORIGINAL BUSHES / WASHERS AND ENLARGE THE HOLES MARKED INTO THE IRON SUPPORTS OF THE MUDGUARD, PHOTO F, WITH A DRILL OF Ø 8,5mm; THEN SET THE WASHERS, DETAIL 12, AS YOU CAN SEE FROM PICTURE F INSTEAD OF THE BUSHES / WASHERS YOU HAVE TAKEN OUT BEFORE.
3. SET THE SUPPORT N.3 AS YOU CAN SEE IN PICTURE G; REPLACE THE ORIGINAL SUPPORT SHOWN IN PICTURE H WITH SUPPORT N.2, PICTURE I, PAYING ATTENTION TO REPLACE ALSO THE THREADED BUSHES UNDER THE ORIGINAL SUPPORT YOU HAVE DISASSEMBLE WITH THE ONES MARKED IN PICTURE I (DETAIL 11);
4. REASSEMBLE THE MUDGUARD AS YOU CAN SEE IN PICTURE L; REASSEMBLE THE ORIGINAL INDICATORS ON THE SUPPORT IN PICTURE M;
5. SET THE MONORACK ARMS, DETAILS 1, AS YOU CAN SEE IN PICTURES N, O AND P; SET THE PLATE (NOT INCLUDED) FOLLOWING THE INSTRUCTIONS INSIDE THE PLATE;
6. CHECK THAT ALL THE SCREWS ARE CORRECTLY TIGHTENED.

F INSTRUCTIONS DE MONTAGE

1. DEMONTER LES PIÈCES DE CARENAGE INDIQUEES EN PHOTO A ET B; DEMONTER ET POSITIONNER COMME INDIQUE EN PHOTOS C ET D LE SUPPORT SOUS LA SELLE POUR FACILITER LES MONTAGES SUIVANTS.
2. DEMONTER LE GARDE-BOUE POSTERIEUR, PHOTO E; LE POSER A L'ENVERS SUR UN PLAN, ENLEVER LES BOUCLES / RONDELLES D'ORIGINE ET ELARGIR LES TROUS MARQUES DANS LES SUPPORTS EN FER DU GARDE-BOUE, PHOTO F, AVEC UNE MECHE DE Ø 8,5MM; ENSUITE POSITIONNER LES RONDELLES, PIÈCES N°12, COMME INDIQUE EN PHOTO F A LA PLACE DES BOUCLES / RONDELLES D'ORIGINE QUI ONT ETE ENLEVEES AUPARAVANT.
3. POSITIONNER COMME INDIQUE EN PHOTO G LE SUPPORT N°3; REMPLACER LE SUPPORT D'ORIGINE INDIQUE EN PHOTO H PAR LE SUPPORT N°2, PHOTO I, EN FAISANT ATTENTION A REMPLACER AUSSI LES ENTRETOISES FILETEES SITUÉES AU DESSOUS DU SUPPORT D'ORIGINE QUE VOUS AVEZ DEMONTE PAR LES ENTRETOISES INDIQUEES EN PHOTO I (PIÈCE N° 11);
4. REMONTER LE GARDE-BOUE COMME INDIQUE EN PHOTO L; PUIS LES CLIGNOTANTS SUR LES SUPPORTS INDIQUEES EN PHOTO M;
5. MONTER LES BRAS DU MONORACK, PIÈCES N°1, COMME INDIQUE EN PHOTOS N, O ET P; MONTER LA PLATINE PORTE-VALISE (NON INCLUSE) EN SUIVANT LES INSTRUCTIONS DANS LA PLATINE MEME;
6. TERMINER LE MONTAGE EN CONTROLANT LE BON SERRAGE DE TOUTES LES VIS.

D BAUANLEITUNG

1. ENTFERNEN SIE DIE HECKVERKLEIDUNG WIE IN DEN BILDERN A UND B BESCHRIEBEN; ENTFERNEN UND STELLEN SIE DIE HALTERUNG UNTER DIE SITZBANK WIE IN DEN BILDERN C UND D ABGEBILDET, UM DIE NÄCHSTEN MONTAGESCHRITTE ZU VEREINFACHEN;
2. DEMONTIEREN SIE DEN HINTEREN KOTFLÜGEL WIE IN BILD E BESCHRIEBEN UND STELLEN DIESEN UMGEKEHRT AUF DIE FLÄCHE. DIE ORIGINALEN ACHSBUCHSEN ENTFERNEN UND DIE AUFGEZEIGTEN LÖCHER MIT EINEM BOHRER (Ø8,5MM) VERBREITERN. DIE SCHEIBEN (POSITION NR. 12) AN DIE STELLE DER ORIGINALSCHEIBEN MONTIEREN WIE IM BILD F GEZEIGT.
3. MONTIEREN SIE DIE HALTERUNG NR. 3 WIE IM BILD G ABGEBILDET; ERSETZEN SIE DIE ORIGINALHALTERUNG MIT DER HALTERUNG NR. 2 (BILD H UND I) UND ACHTEN SIE DARAUF, DIE GEWINDEBUCHSE UNTER DER ORIGINALHALTERUNG ZU ERSETZEN (WIE DIE IM BILD I - DETAIL 11);
4. MONTIEREN SIE DEN KOTFLÜGEL WIEDER (BILD L); SOWIE AUCH DIE ORIGINALBLINKER AN DIE HALTERUNG (BILD M);
5. DIE MONORACK ARME MONTIEREN (DETAIL 1) WIE IN DEN BILDERN N, O UND P ABGEBILDET; DIE TRÄGERPLATTE MONTIEREN (IST NICHT ENTHALTEN) WIE IN DER ENTHALTENEN ANBAUANLEITUNG BESCHRIEBEN;
6. ZULETZT ÜBERPRÜFEN SIE, DASS ALLE SCHRAUBEN FESTGEZOGEN WURDEN.

ES

INSTRUCCIONES DE MONTAJE

1. DESMONTAR LAS PARTES DEL CARENADO INDICADAS EN LAS IMÁGENES A y B; DESMONTAR Y COLOCAR COMO MUESTRA EN LA FOTOGRAFIA C y D EL SOPORTE BAJO EL ASIENTO PARA SIMPLIFICAR LOS ANCLAJES SUCEIVOS;
2. DESMONTAR EL GUARDABARROS POSTERIOR, IMAGEN E, APOYARLO DEL REVES SOBRE UNA SUPERFICIE LISA, SACAR LAS ARANDELAS/ORIGINALES Y AMPLIAR LOS AGUJEROS QUE SE ENCUENTRAN EN LOS SOPORTES DE HIERRO DEL GUARDABARROS, IMAGEN F, CON UNA BROCA DE Ø8,5mm; LUEGO COLOCAR LAS ARANDELAS, REFERENCIA 12, COMO SE INDICA EN LA FOTOGRAFIA F EN LUGAR DE LAS ARANDELAS ORIGINALES QUITADAS CON ANTERIORIDAD;
3. COLOCAR COMO INDICA EN LA FOTOGRAFIA G EL SOPORTE N°3; SUSTITUIR EL SOPORTE ORIGINAL INDICADO EN FOTOGRAFIA H POR EL SOPORTE N°2, FOTOGRAFIA I, PONER ATENCION EN SUSTITUIR TAMBIEN LOS ELEVADORES COLOCADOS BAJO EL SOPORTE ORIGINAL QUE HABEIS DESMONTADO POR LOS INDICADOS EN FOTOGRAFIA I (DETALLE 11);
4. VOLVER A MONTAR EL GUARDABARROS COMO INDICA LA FOTOGRAFIA L; REENSAMBLAR LOS INTERMITENTES ORIGINALES EN EL SOPORTE INDICADO EN FOTOGRAFIA M;
5. MONTAR LOS SOPORTES DEL MONORACK, DETALLE 1, COMO MUESTRAN LAS FOTOGRAFIAS N, O y P; MONTAR LA PLETINA (NO INCLUIDA) SEGÚN LAS INSTRUCCIONES DE LA MISMA PLETINA
6. TERMINAR EL MONTAJE COMPROBANDO QUE TODOS LOS TORNILLOS ESTEN BIEN APRETADOS.