

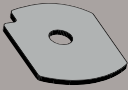

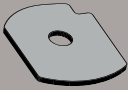





A1117A - A1117A

SPECIÁLIS RÖGZÍTŐ KIT

HONDA SH 125i - 150i ABS (2012 - 2013)

N°	Leírás	Méret	Kód	Mennyiség	
1	Rögzítő elem	-	-	2 (Jobb;Bal)	
2	Védő gumibetétek	-	Z2184	1 Bal	
3	Védő gumibetétek	-	Z2184	1 Jobb	
4	Csavar	TCEI M8x20	820TCE	4	
5	Csavar	TBEI M6x25	625TBEI	4	
6	Rögzítő persely	-	Z871N	4	
7	Gumi Távtartó	-	Z268	4	
8	"T" Bilincs	-	Z870	4	
9	Gumi Távtartó	-	8TAP	2	
10	Alátét	Ø8	8RON	4	
11	-	-	-	1	

A1117A - A1117A
SPECIÁLIS RÖGZÍTŐ KIT

HONDA SH 125i - 150i ABS (2012 - 2013)

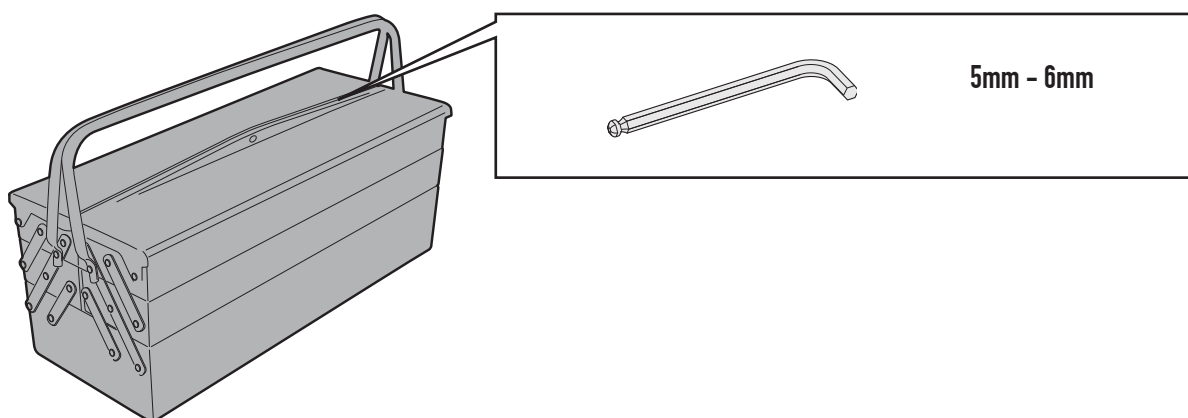

A1117A - A1117A SPECIÁLIS RÖGZÍTŐ KIT

HONDA SH 125i - 150i ABS (2012 - 2013)

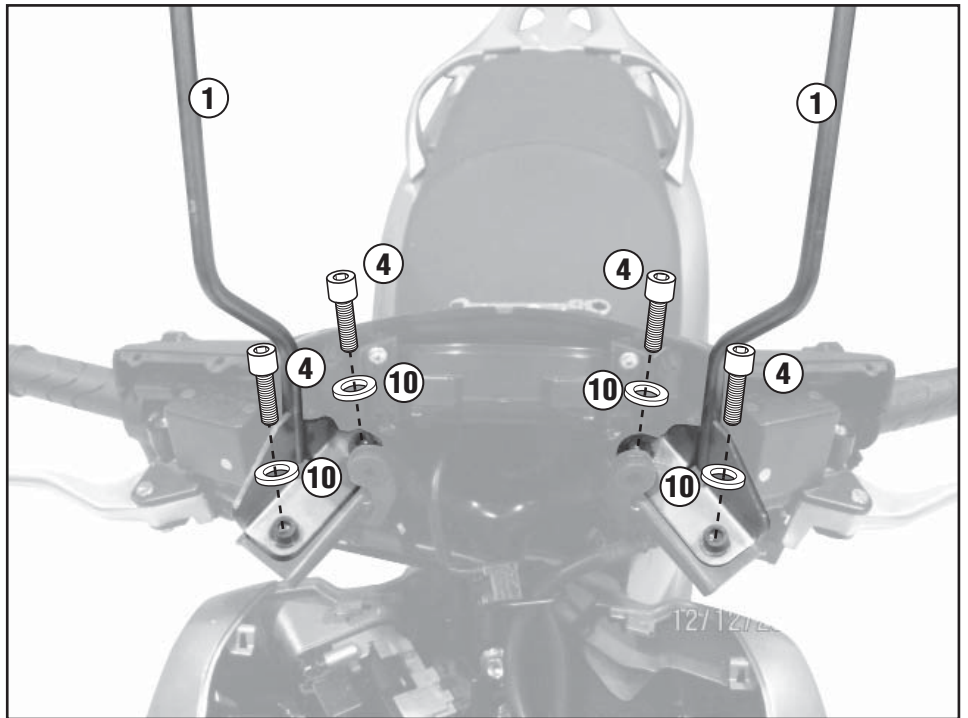
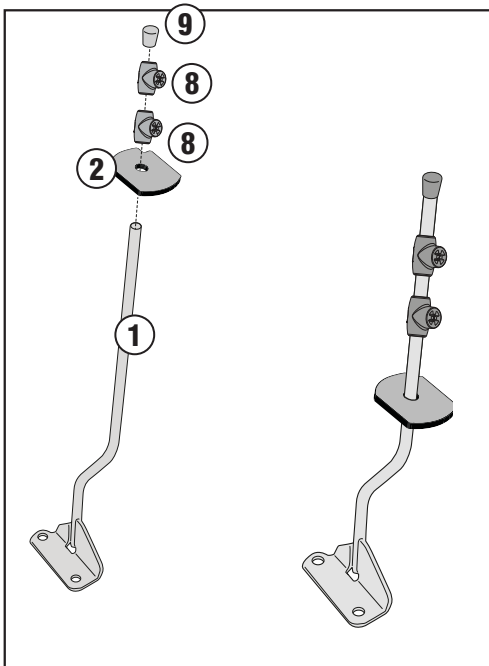
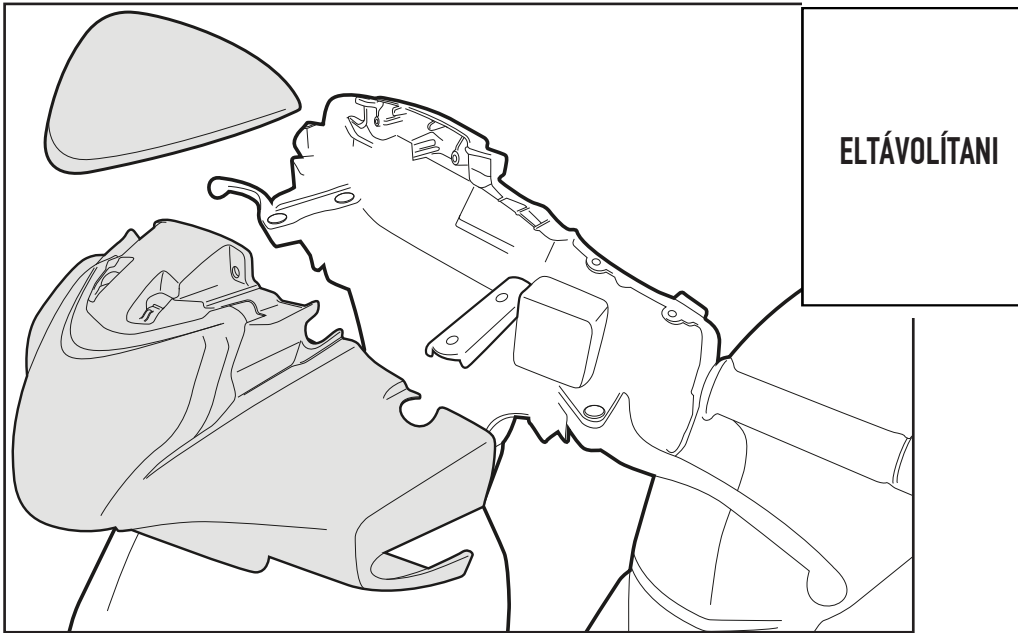

A1117A - A1117A SPECIÁLIS RÖGZÍTŐ KIT

HONDA SH 125i - 150i ABS (2012 - 2013)

