





A1125A - A1125A

SPECIFIKUS RÖGZÍTŐ KIT

HONDA SH 125 MODE (2013)

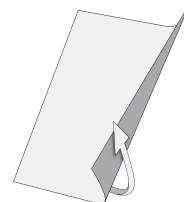

N°	MEGNEVEZÉS	MÉRET	KÓD	MENNYISÉG	
1	RÖGZÍTŐKAR	-	A1125DXS A1125SXS	2	
2	RÖGZÍTŐELEM	4mm	GNB951V	2	
3	CSAVAR	M6x25	625TBEI	4	
4	CSAVAR	M10x65 1.25	1065TES	2	
5	TÁVTARTÓ	Ø16x40 - 12mm	C16L40F12FET	2	
6	ALÁTÉT	Ø10	10RON	2	
7	ALÁTÉT	Ø8	8RON	2	
8	ALÁTÉT	Ø14 - 8mm	814RONZ	2	
9	ANYA	M8	8DADIES	2	
10	ALÁTÉT	-	Z1072	2	



A1125A - A1125A

SZERELÉSI ÚTMUTATÓ

HONDA SH 125 MODE (2013)

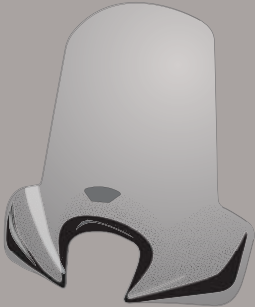
N°	MEGNEVEZÉS	MÉRET	KÓD	MENNYISÉG	
11	RÖGZÍTŐELEM	-	Z4861	4	
12	MŰANYAG GUMIELEM	-	Z4862	4	
13	GUMI REZGÉSCSILLAPÍTÓ	-	Z4860	4	
14	-	-	-	-	

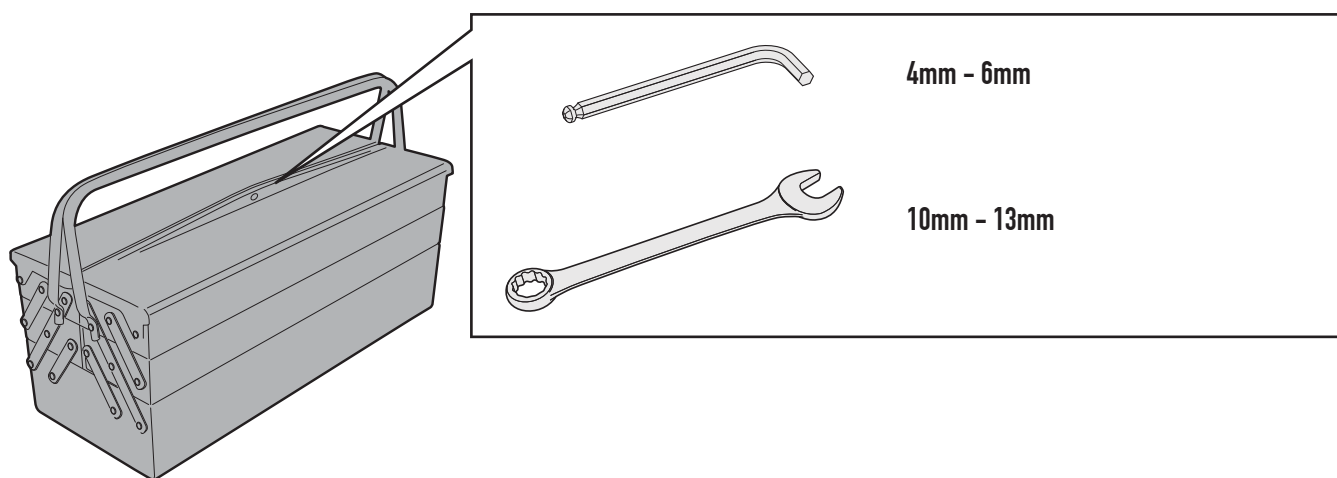

A1125A - A1125A

SPECIFIKUS RÖGZÍTŐ KIT

HONDA SH 125 MODE (2013)

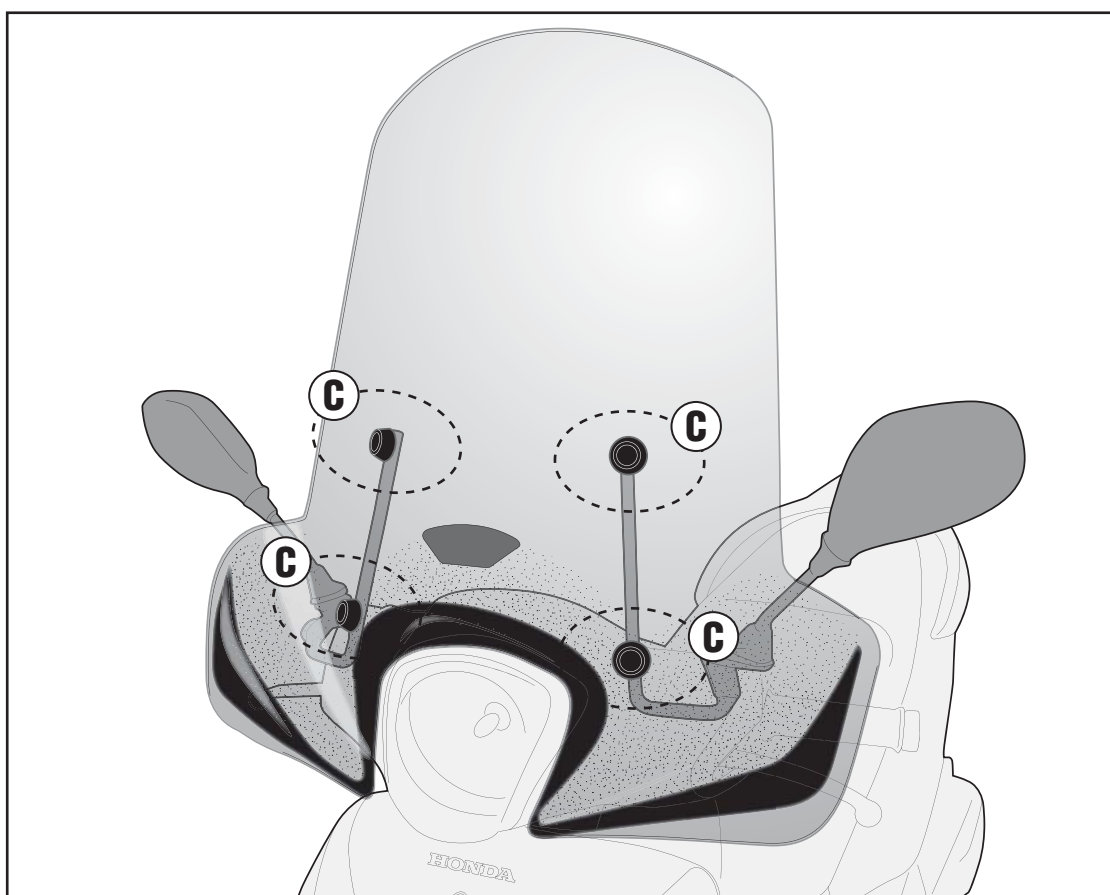
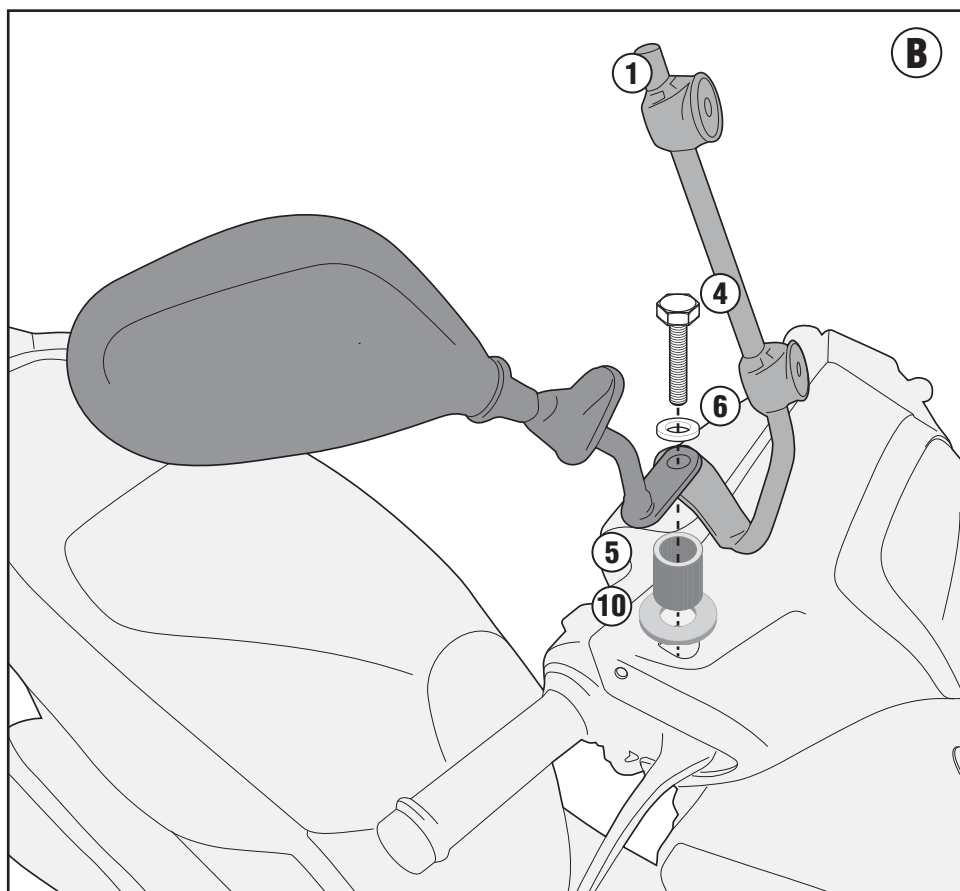
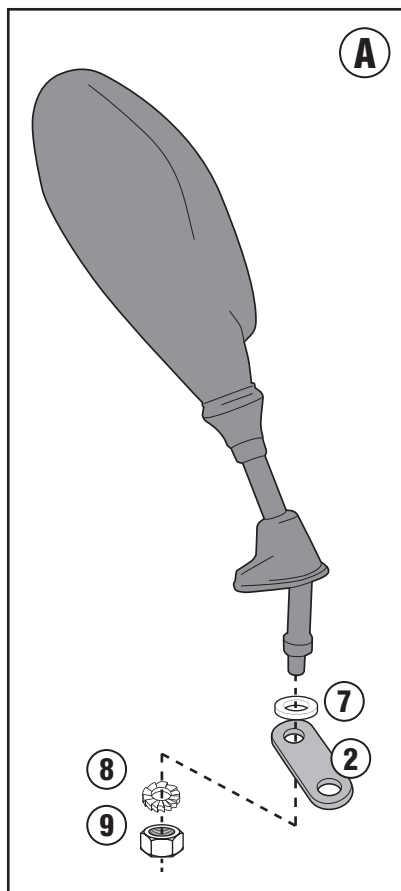

A1125A - A1125A
SPECIFIKUS RÖGZÍTŐ KIT

HONDA SH 125 MODE (2013)

