

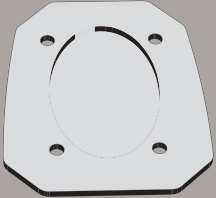
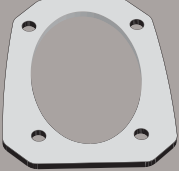
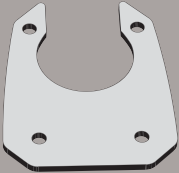

ES4103 - ES4103K OLDALSZTENDER TALP

KAWASAKI VERSYS 650 (2010-2013)

| N° | Leírás | Méret | Kód | Mennyiség | |
|----|--------------|-------------------|--------|-----------|---|
| 1 | Rögzítő elem | Sp. 6mm | GL2487 | 1 |  |
| 2 | Rögzítő elem | INOX 316, Sp. 4mm | GL2489 | 1 |  |
| 3 | Rögzítő elem | INOX 316, Sp. 2mm | GL2488 | 1 |  |
| 4 | Csavar | M5x12 | - | 4 |  |

ES4103 - ES4103K
OLDALSZTENDER TALP
KAWASAKI VERSYS 650 (2010-2013)

Figyelem!

Az oldalsztender talp rögzítése megváltoztatja a dőlésszöget. Használjon csavarrögzítőt a csavarokra.

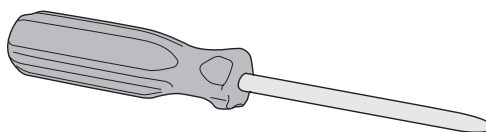
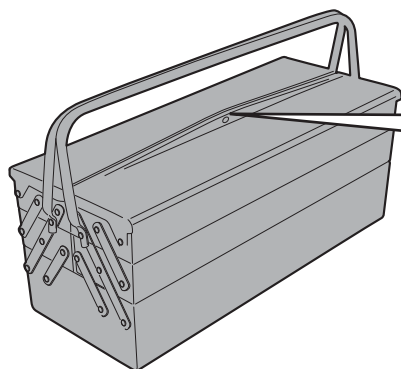
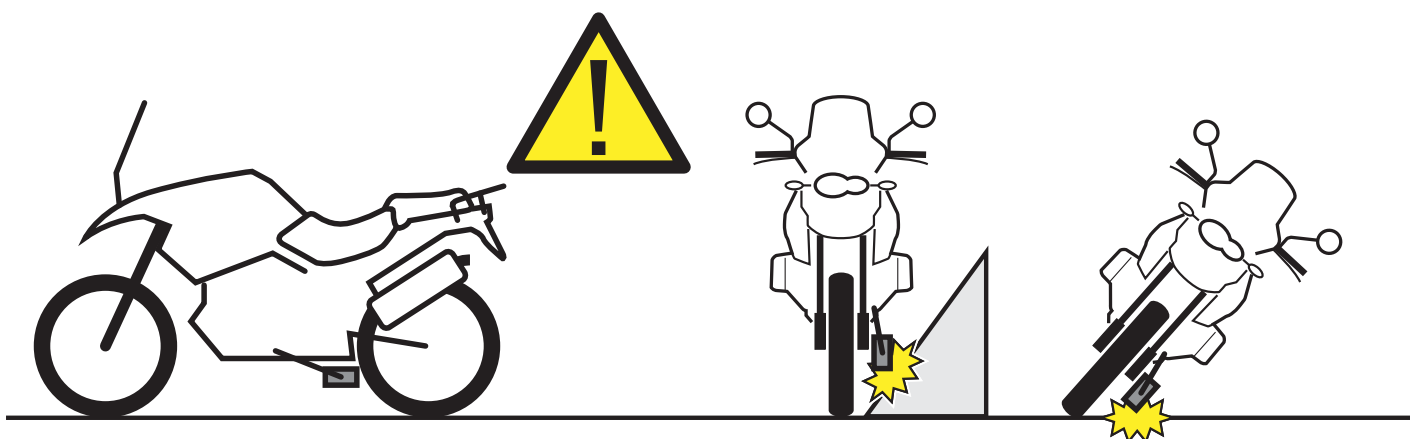

ES4103 - ES4103K
OLDALSZTENDER TALP

KAWASAKI VERSYS 650 (2010-2013)

