

SPECIFIKUS OLDALDOBOZ TARTÓ KONZOL

YAMAHA FZ6-FZ6 Fazer
"04/06"

SZERELÉSI ÚTMUTATÓ

1

DOBOZTARTÓ KONZOL
DARAB: 2 (Dx-Sx)

2

HÍDELEM
DARAB: 1

3

CSAVAR M8x45mm
DARAB: 2

4

CSAVAR M6x40mm
DARAB: 2

5

CSAVAR M8x55mm
DARAB: 2

6

ALÁTÉT Ø8x14mm
DARAB: 2

7

ALÁTÉT Ø8mm
DARAB: 4

8

GOMBA Z125
DARAB: 2

9

ANYA M8
DARAB: 2

10

SPECIÁLIS ANYA
V629
DARAB: 2

11

INDEXTARTÓ KAR
DARAB: 2 (Dx-Sx)

12

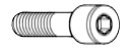
TÁVTARTÓ GYŰRŰ
DARAB: 2

13

CSAVAR M6x25mm
DARAB: 2

14

ALÁTÉT Ø6mm
DARAB: 4

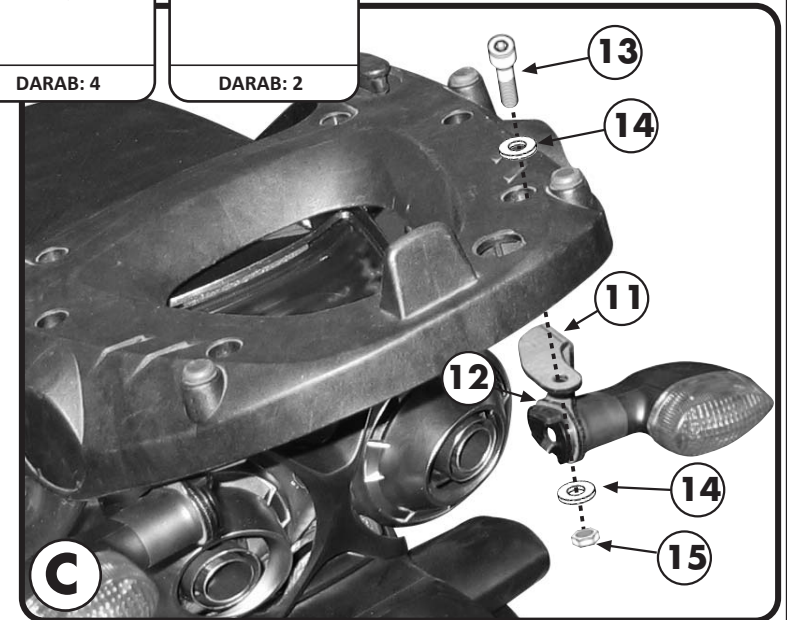
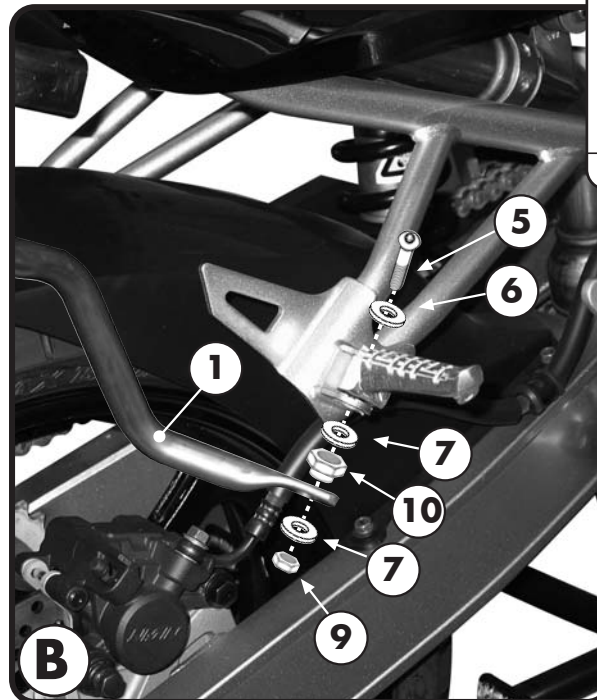
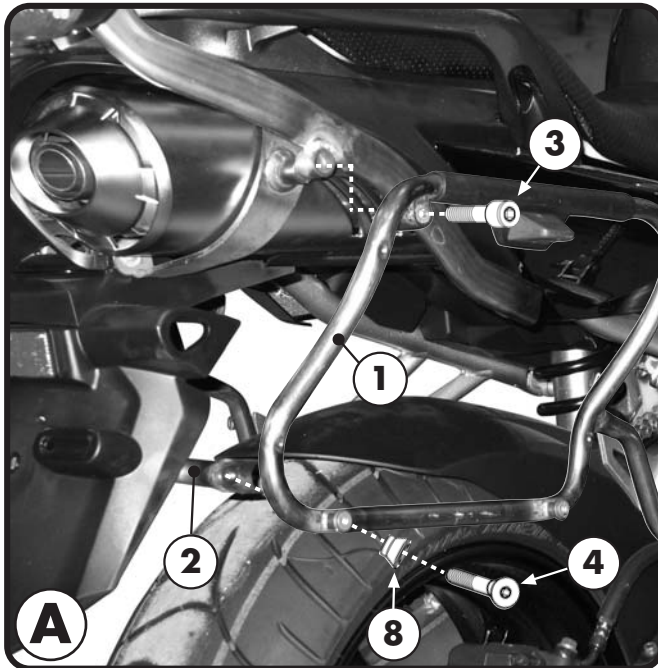
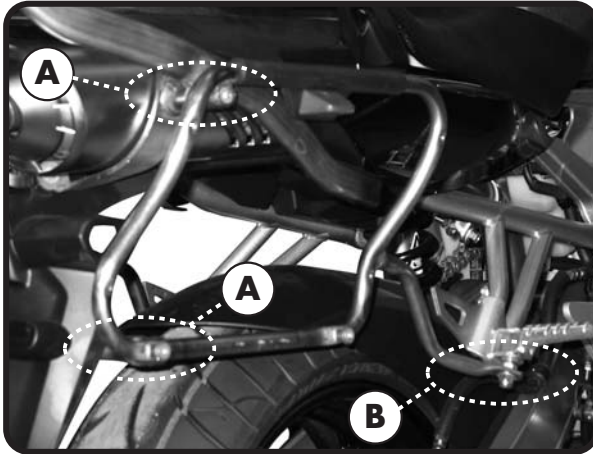
15

ANYA M6 FEKETE
DARAB: 2



SPECIFIKUS OLDALDOBOZ TARTÓ KONZOL

YAMAHA FZ6-FZ6 Fazer
"04/06"

SZERELÉSI ÚTMUTATÓ

H FELSZERELÉSI ÚTMUTATÓ

1. HELYEZZE FEL AZ OLDALDOBOZ TARTÓ KONZOLT AHOGY AZ "A" ÁBRA MUTATJA ÉS HAJTSA VÉGRE A BEMUTATOTT FOLYAMATOT;
2. RÖGZÍTSE AZ OLDALDOBOZ TARTÓ KONZOLT A LÁBTARTÓHOZ ÚGY, AHOGY A "B" ÁBRA MUTATJA.
3. HELYEZZE FEL AZ IDEX TARTÓ KART A "C" ÁBRA SZERINT.

GB MOUNTING INSTRUCTIONS

1. PLACE THE SUPPORT N°1 AS SHOWN IN PICTURE A AND CARRY OUT THE MOUNTING PROCEDURE SUGGESTED;
2. FIX THE SUPPORT N°1 TO THE FOOTREST AS SHOWN IN PICTURE B;
3. MOUNT THE INDICATOR HOLDER AS SHOWN IN PICTURE C;

F INSTRUCTIONS DE MONTAGE

1. POSITIONNER LES SUPPORTS N°1 COMME INDIQUE EN PHOTO A ET PROCEDER AU MONTAGE ;
2. FIXER LES SUPPORTS N°1 AUX REPOSE-PIEDS COMME INDIQUE EN PHOTO B ;
3. MONTER LES SUPPORTS DE CLIGNOTANTS COMME INDIQUE EN PHOTO C ;

D BAUANLEITUNG

1. POSITIONIEREN SIE DIE HALTERUNG NR. 1 WIE IM BILD A BESCHRIEBEN UND FÜHREN SIE DIE MONTAGESCHRITTE DURCH.
2. BEFESTIGEN SIE DIE HALTERUNG NR. 1 AN DEN FUßRASTEN WIE IM BILD B BESCHRIEBEN;
3. MONTIEREN SIE DIE BLINKERHALTERUNG WIE IM BILD C BESCHRIEBEN.

ES INSTRUCCIONES DE MONTAJE

1. POSICIONAR EL PORTAMALETAS LATERAL TUBULAR TAL Y COMO SE INDICA EN LA FIGURA "A" , SIGUIENDO LAS INSTRUCCIONES PRESENTADAS.
2. FIJAR EL SOPORTE AL PEDAL, TAL Y COMO SE INDICA EN LA FIGURA "B".
3. MONTARE EL SOPORTE TAL Y COMO SE INDICA EN LA FIGURA "C".