

TN5119 - KN5119

SPECIFIKUS BUKÓCSŐ

BMW S1000XR (2015)

N°	Megnevezés	Méret	Kód	Mennyiség
1	Bukócső	-	TN5119 (dx-sx)	2 (dx-sx)
2	Rögzítőelem	-	GL2997P	1
3	Csavar	TBEI M10x20	1020TBEI	2
4	Csavar	TBEI M10x25	1025TBEI	1
5	Csavar	TEF M8x25	825TEF	2
6	Csavar	TECF M10x65	1065TECF	2
7	Csavar	TECF M10x80	1080TECF	1
8	Alátét	-	101RON	3
9	Alátét	-	10RON	2
10	Alátét	-	258RON	1
11	Távtartó	Ø 22x5 furat 10,5	C22L5F10,5T	1
12	Távtartó	Ø 20x10 furat 10,5	C20L10F10,5T	4
13	Gyári alkatrészek	-	-	-

TN5119 - KN5119

SPECIFIKUS BUKÓCSŐ

BMW S1000XR (2015)

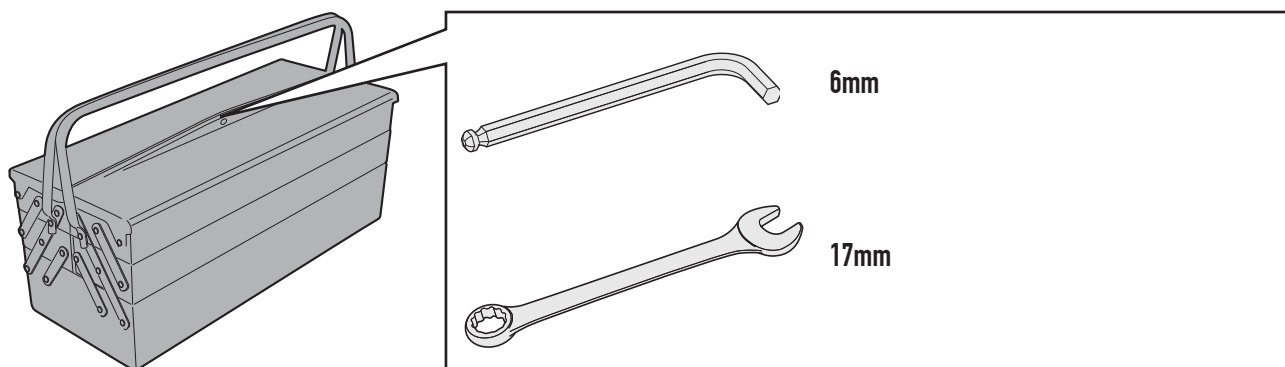
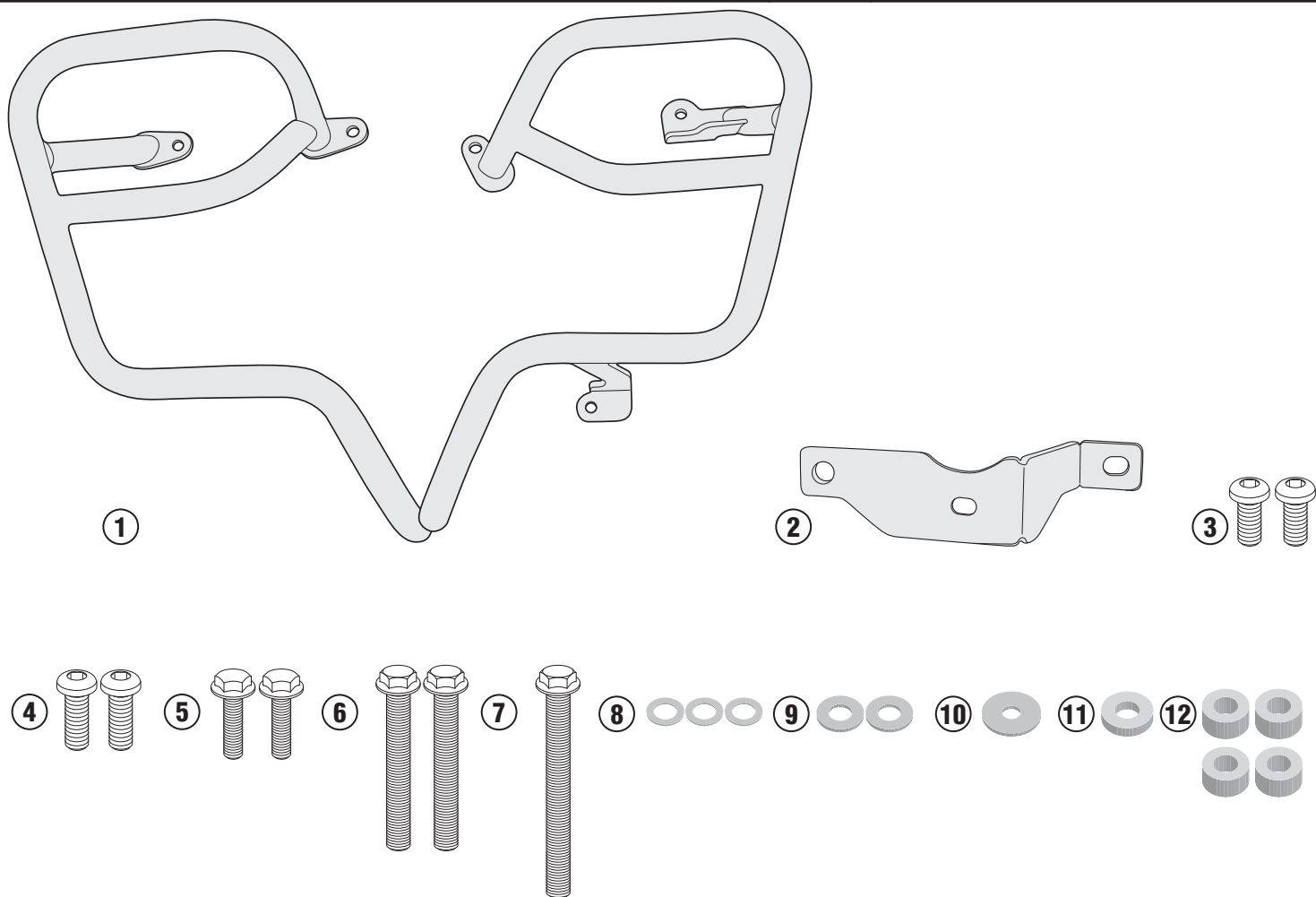

TN5119 - KN5119

SPECIFIKUS BUKÓCSŐ

BMW S1000XR (2015)

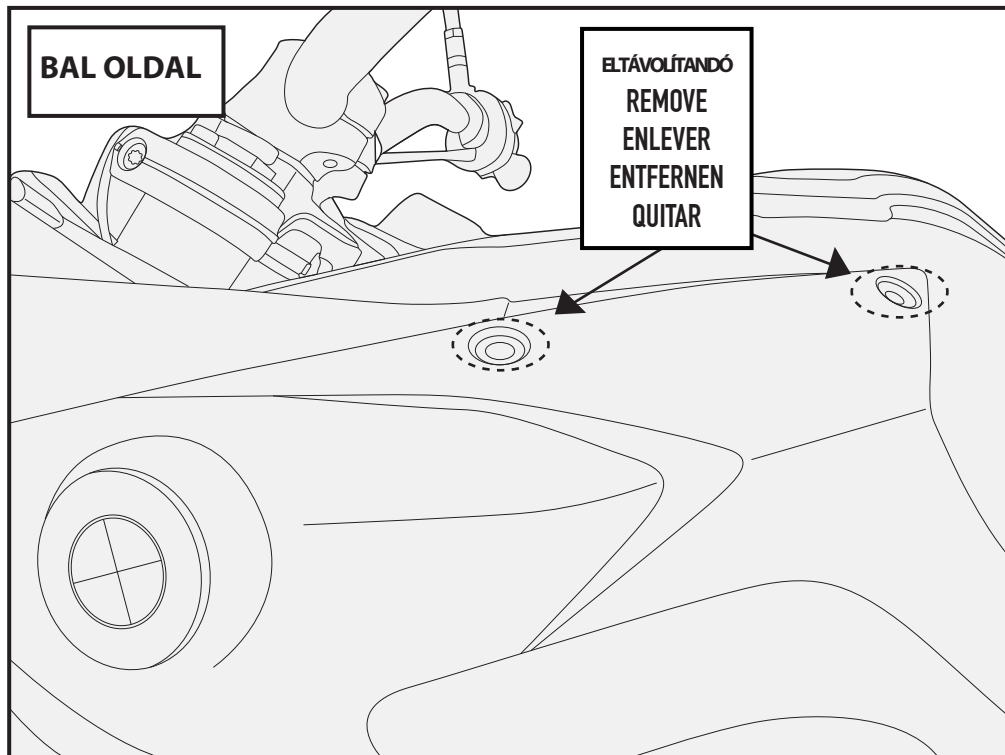
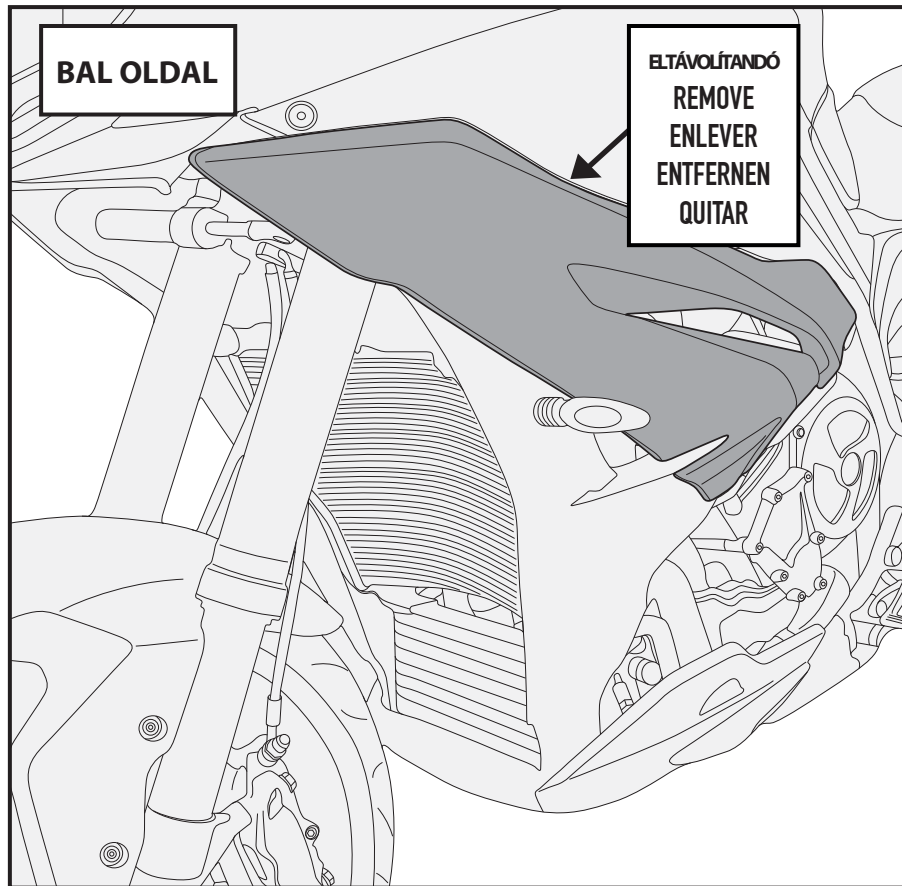

TN5119 - KN5119

SPECIFIKUS BUKÓCSŐ

BMW S1000XR (2015)

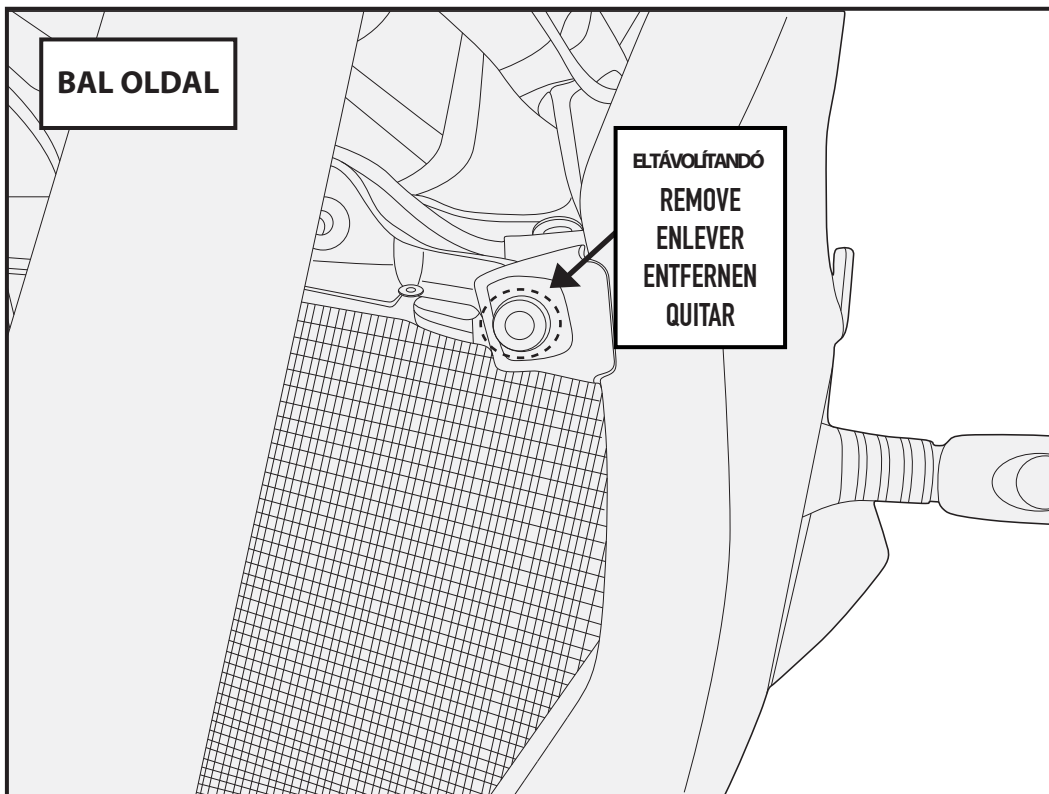
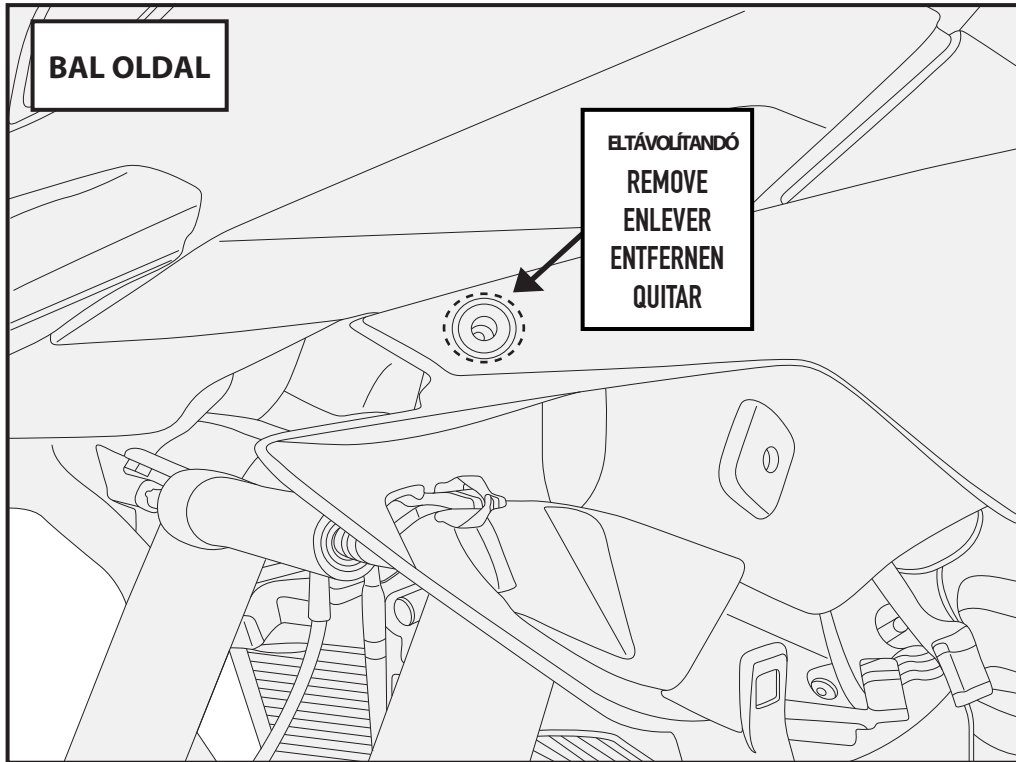

TN5119 - KN5119

SPECIFIKUS BUKÓCSŐ

BMW S1000XR (2015)

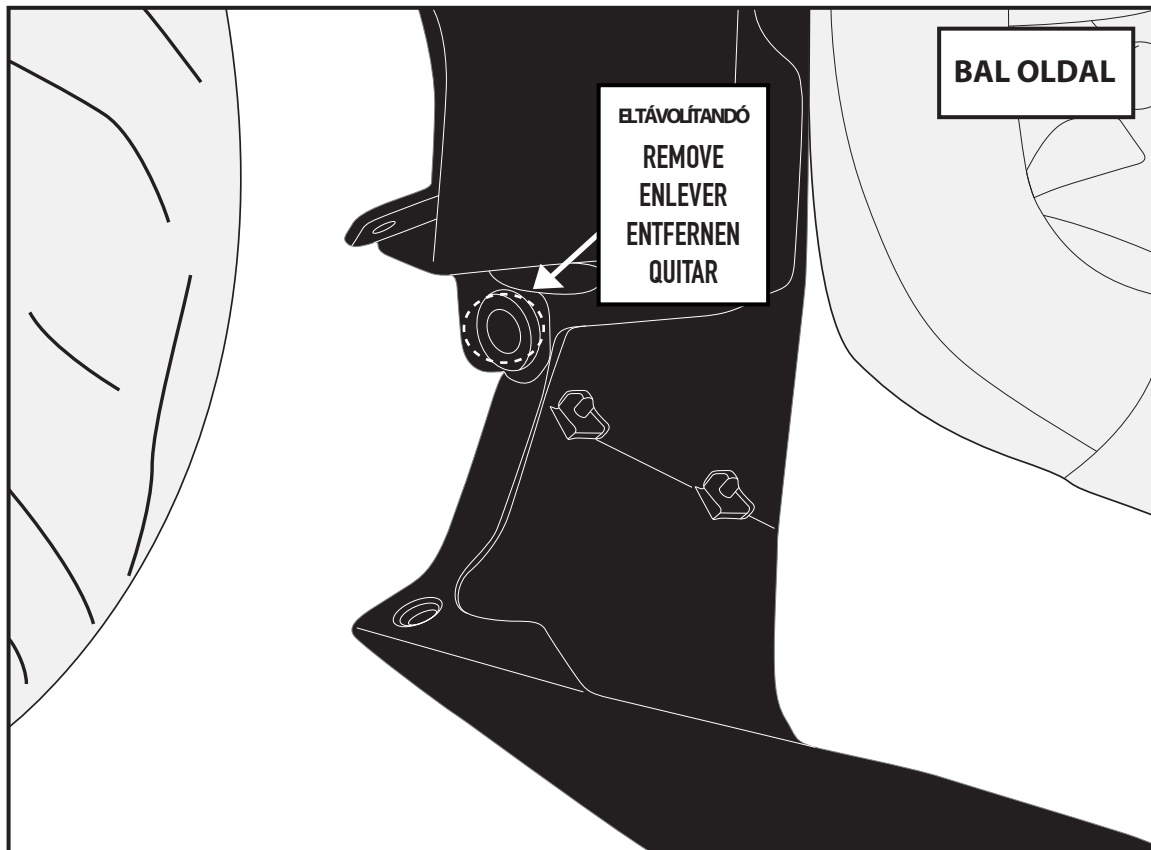
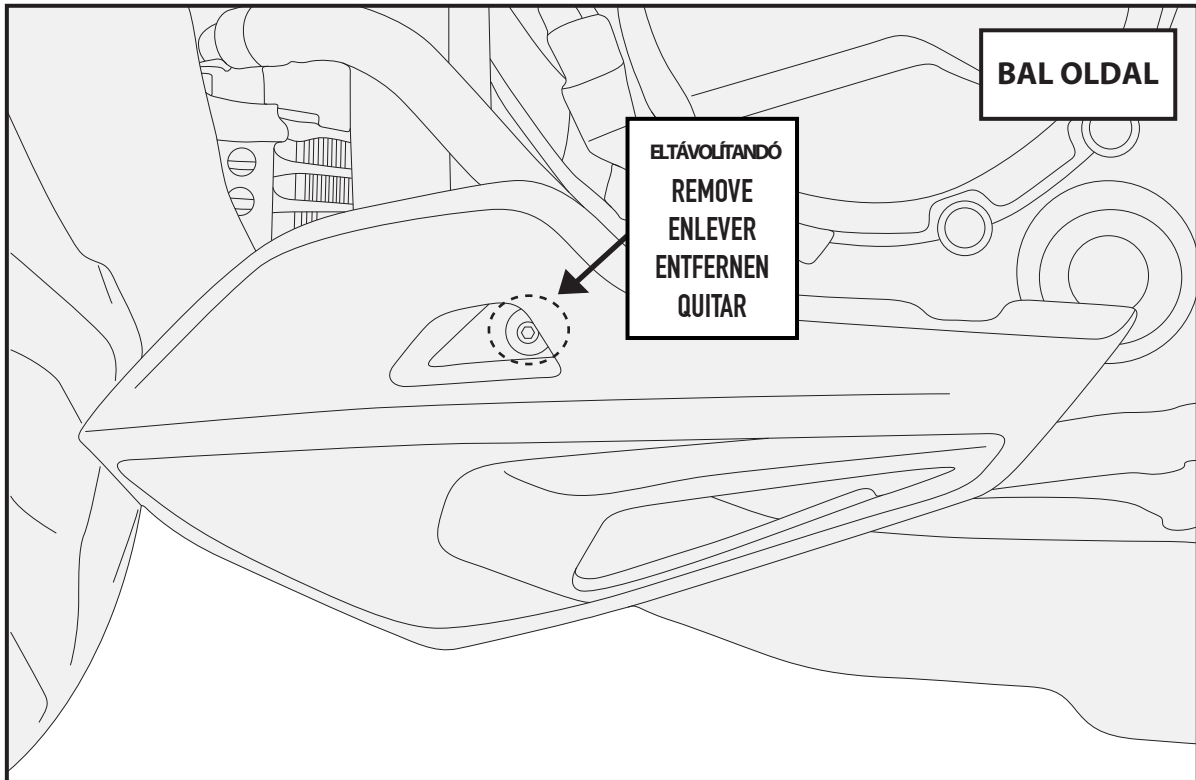

TN5119 - KN5119

SPECIFIKUS BUKÓCSŐ

BMW S1000XR (2015)

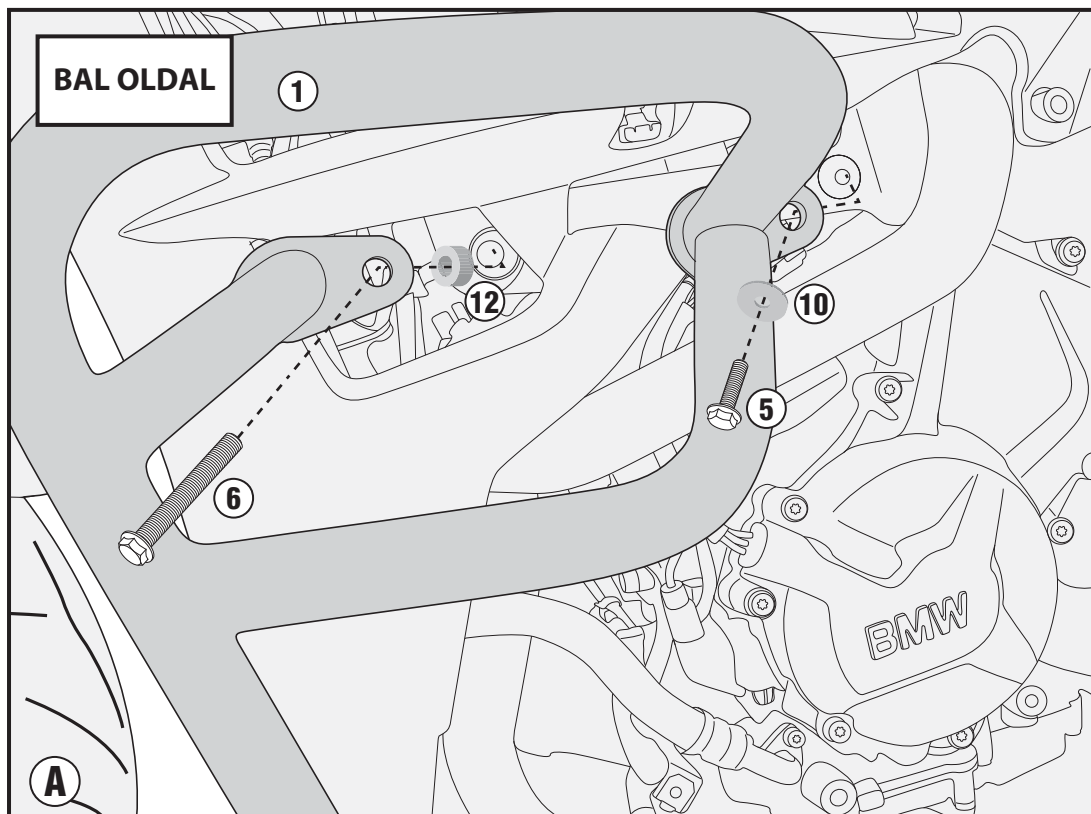
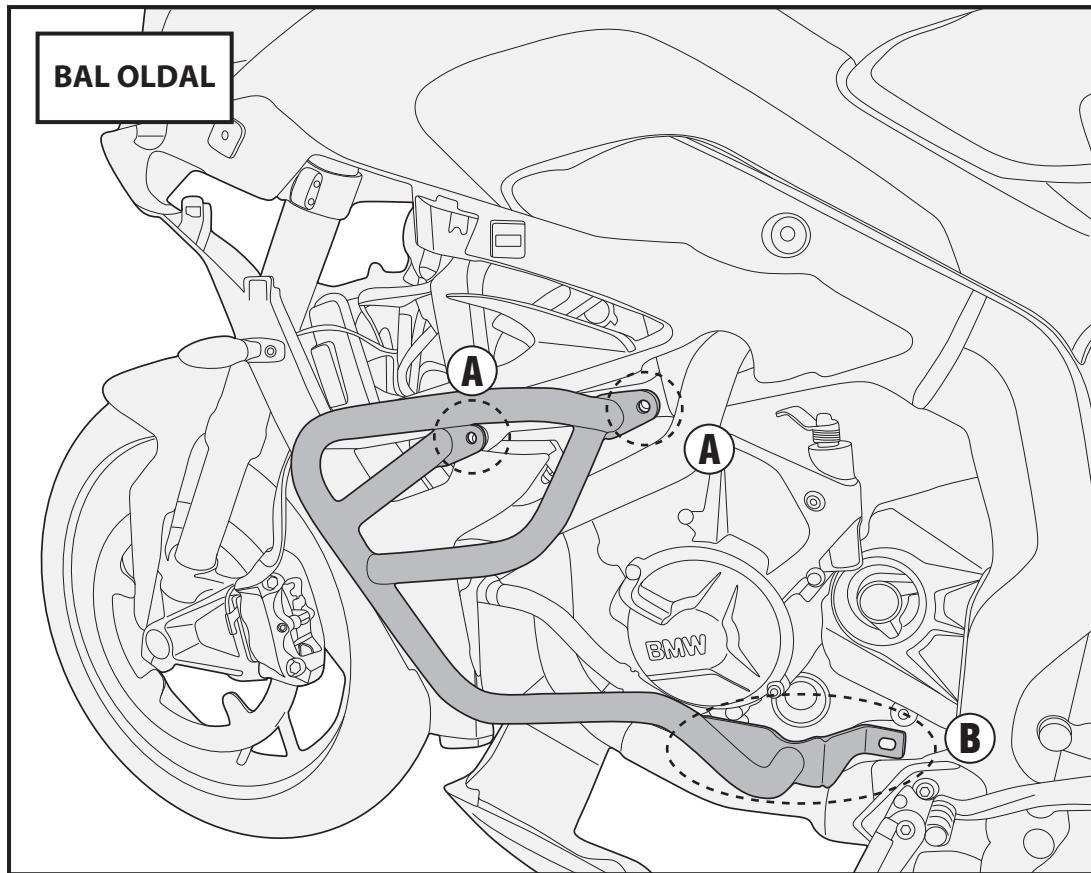

TN5119 - KN5119

SPECIFIKUS BUKÓCSŐ

BMW S1000XR (2015)

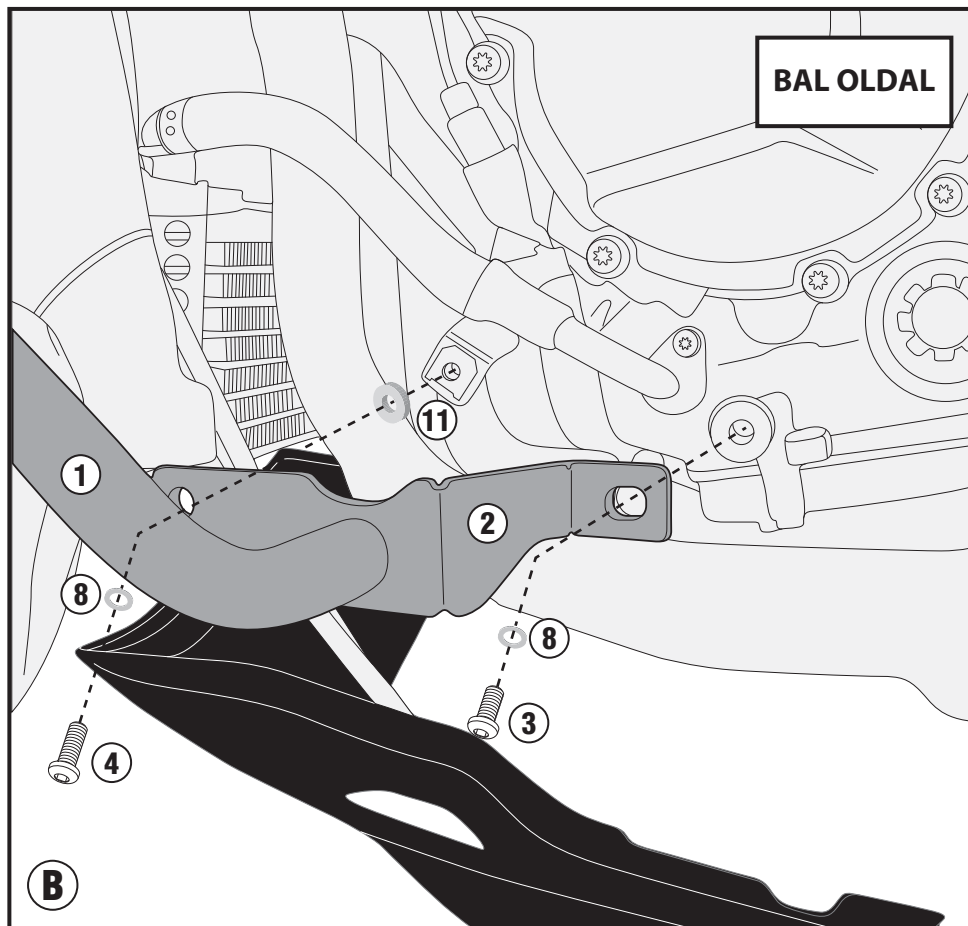
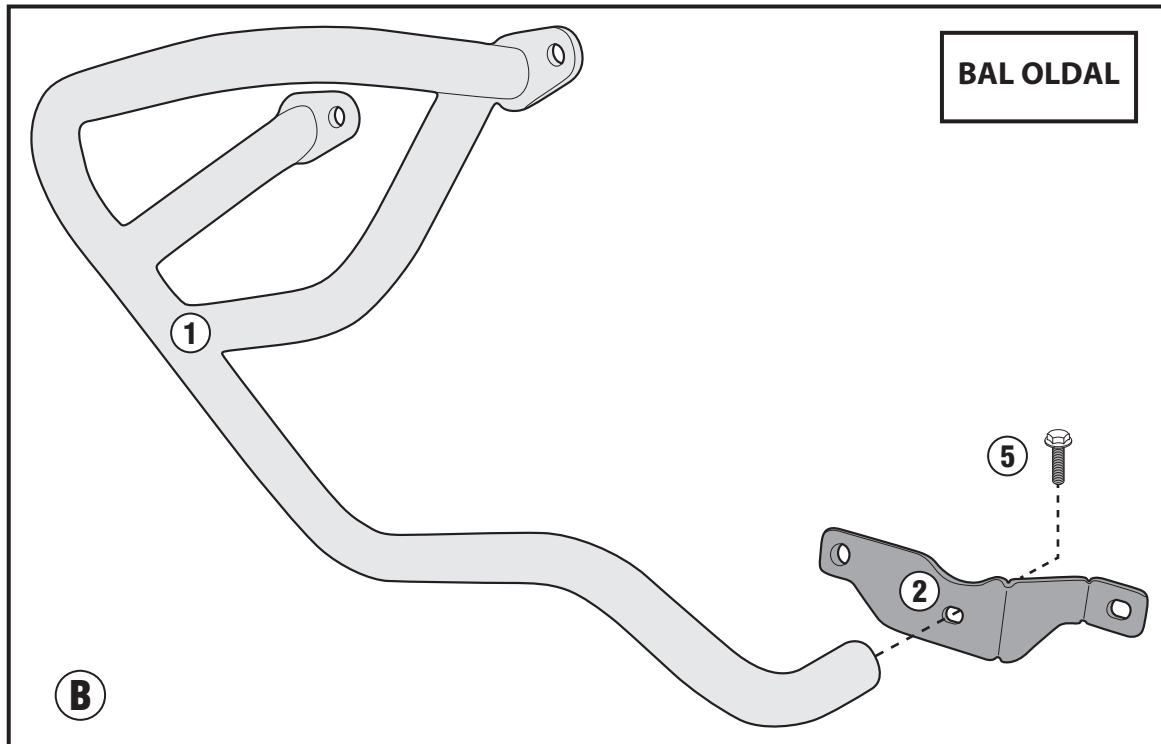

TN5119 - KN5119
SPECIFIKUS BUKÓCSŐ
BMW S1000XR (2015)

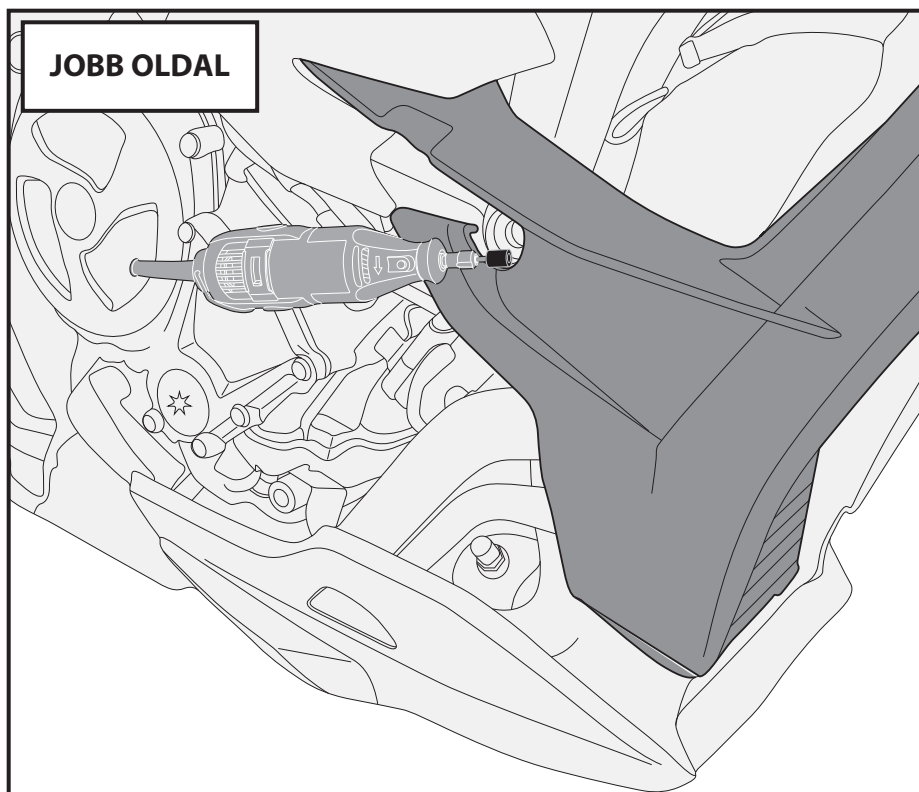
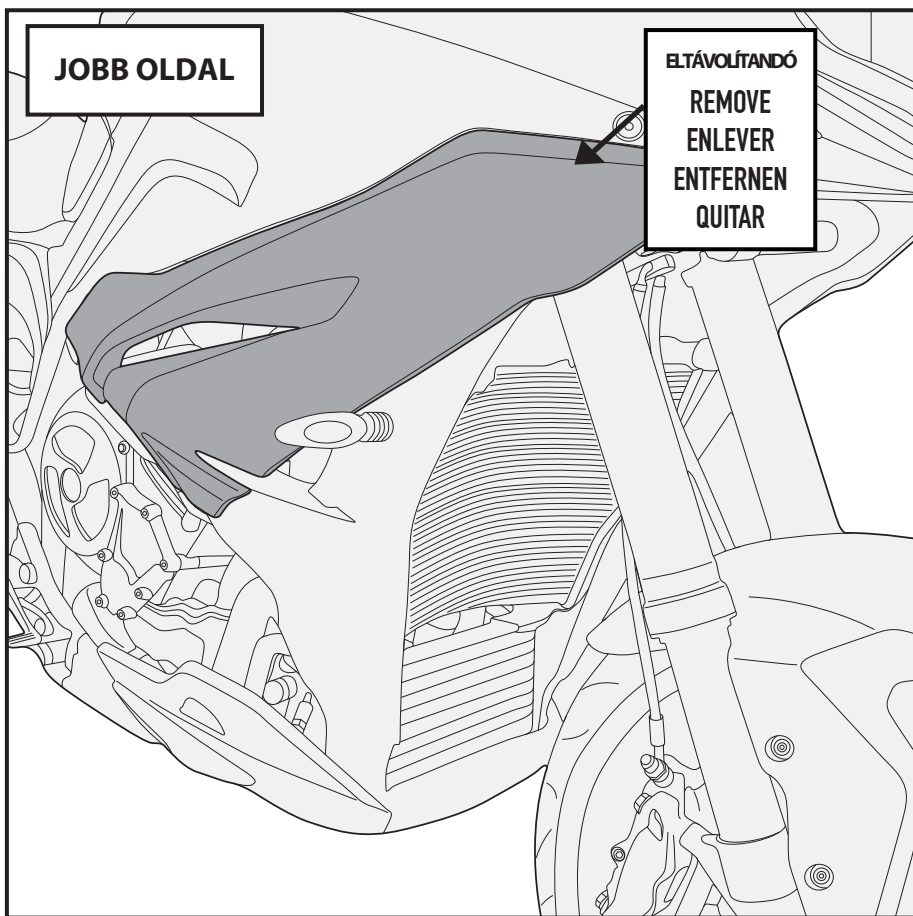

HU: Fúrjon akkora lyukat, hogy a távtartó átférjen.

EN: Make a hole large enough to allow the spacer to be passed through it.

DE: Vergrößern Sie den im Bild gezeigten Bereich, um ausreichend Platz für das Distanzstück zu erhalten.

FR: Faire un trou pour le passage de l'entretoise.

ES: Hacer un agujero por el pasaje del distanciador.

PT: Criar um furo para a passagem do espaçador

TN5119 - KN5119

SPECIFIKUS BUKÓCSŐ

BMW S1000XR (2015)

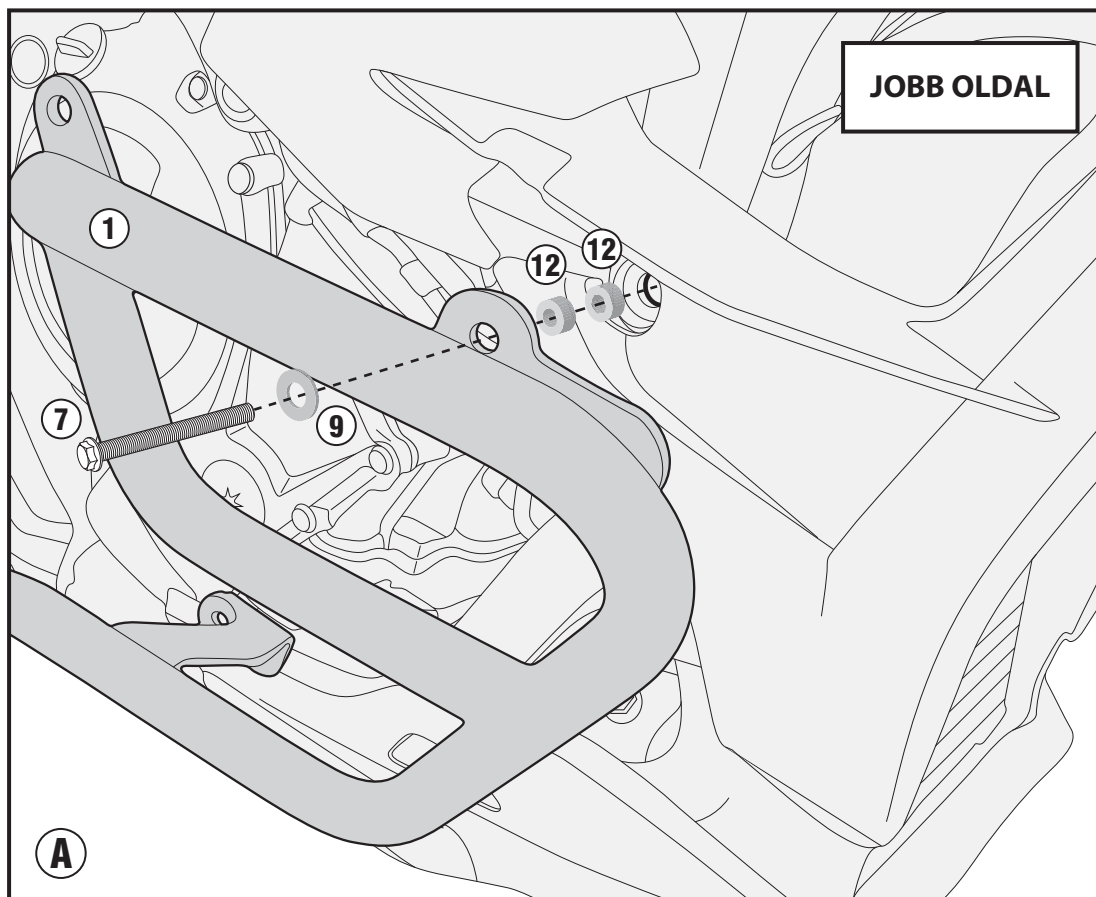
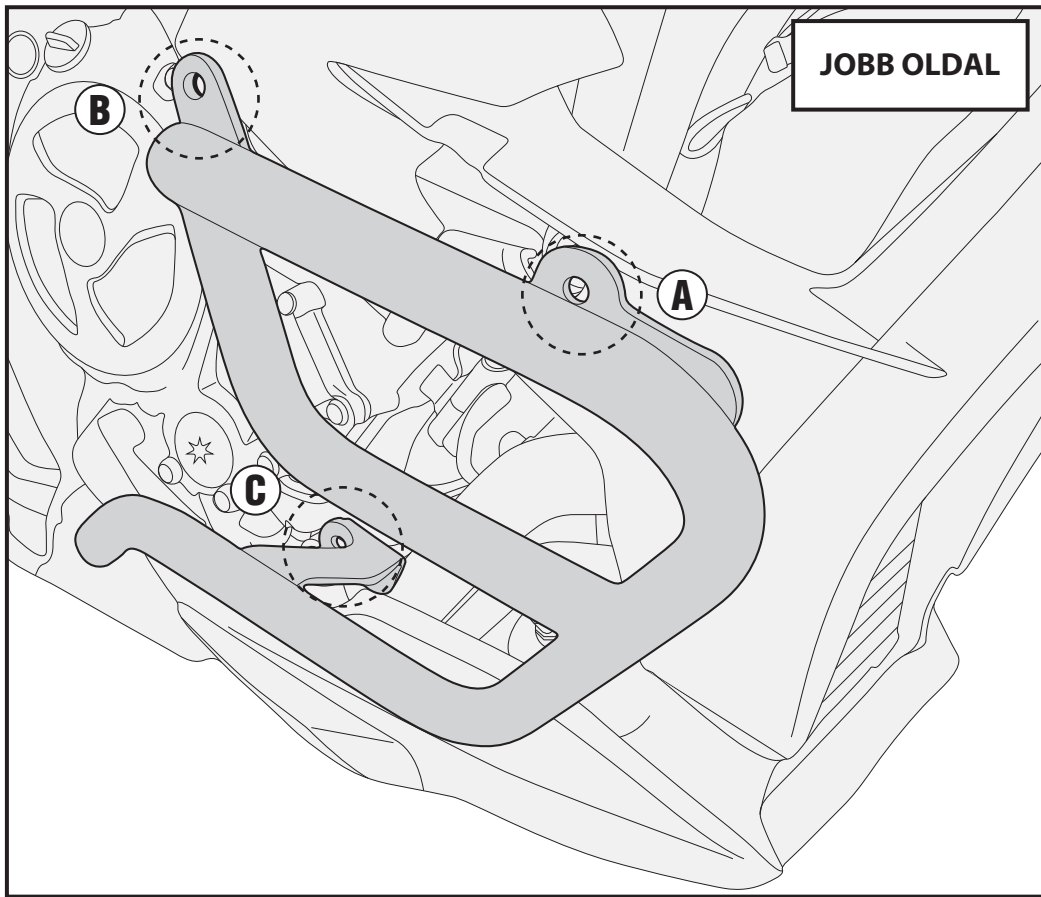

TN5119 - KN5119

SPECIFIKUS BUKÓCSŐ

BMW S1000XR (2015)

