

TN7708 – KN7708

Specialis Bukócső

KTM DUKE 790 (2018)

| N° | Leírás | Méret | Kód | Mennyiség |
|----|--------------------------|---------------|--------------------------|--------------|
| 1 | Bukócső | - | GNB2187DXV GNB2187SXV | 2 (Jobb;Bal) |
| 2 | Csavar | TCEX M10x50 | 1050TCEX | 1 |
| 3 | Csavar | TCEX M10X90 | 1090TCEX | 2 |
| 4 | Csavar | TCEX M10X80 | 1080TCEX | 1 |
| 5 | Csavar | TCEX M10X60 | 1060TCEX | 1 |
| 6 | Rozsdamentes acél Alátét | Ø10 | 10RON SX | 5 |
| 7 | Távtartó | Ø16x40 12mm | C16L40F12FET | 2 |
| 8 | Távtartó | Ø16x12 12mm | C16L12F12FET | 1 |
| 9 | Távtartó | Ø20x22 10,5mm | C20L22F10,5T | 2 |
| 10 | Távtartó | Ø22x6 10,5mm | C22L6F10,5T | 1 |
| 11 | Távtartó | Ø22x5 10,5mm | C22L5F10,5T | 1 |
| 12 | Távtartó | Ø18x30 10,5mm | C18L30F10,5T | 1 |
| 13 | Távtartó | Ø20x5 11,5mm | C20L5F11,5T | 1 |
| 14 | Eredeti Alkatrészek | - | - | - |

TN7708 - KN7708

Specialis Bukóscő

KTM DUKE 790 (2018)

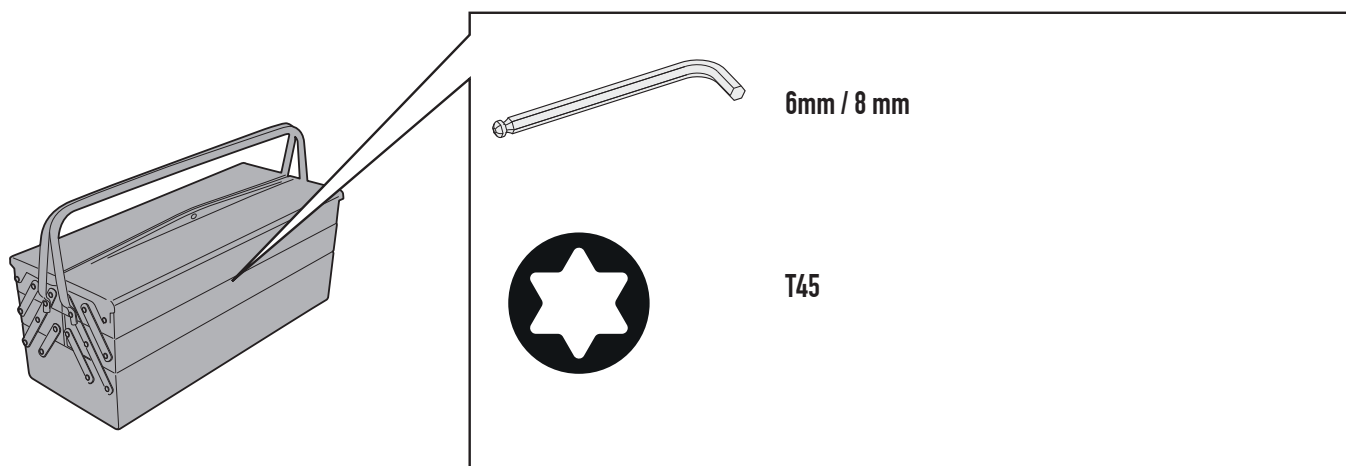
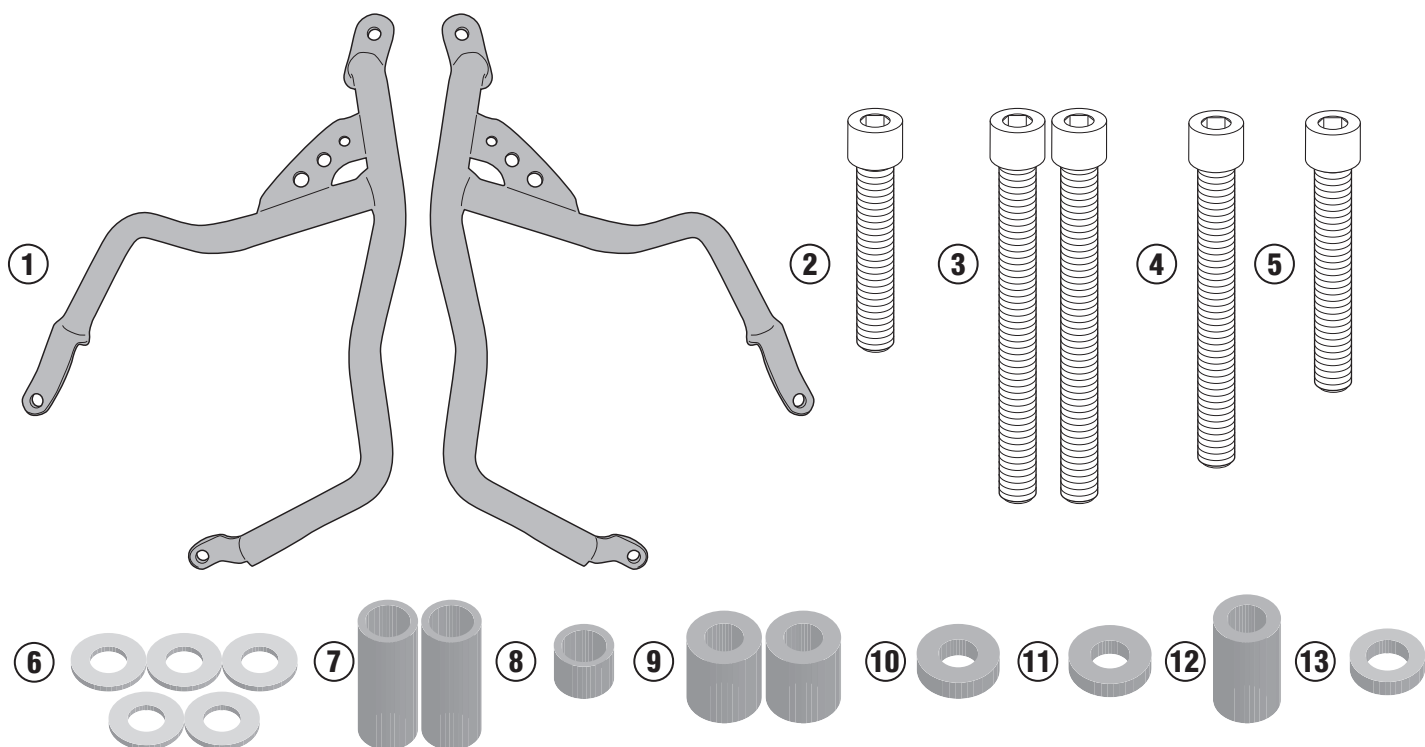

TN7708 - KN7708

Specialis Bukóscő

KTM DUKE 790 (2018)

Jobb oldal

ELTÁVOLÍTANI

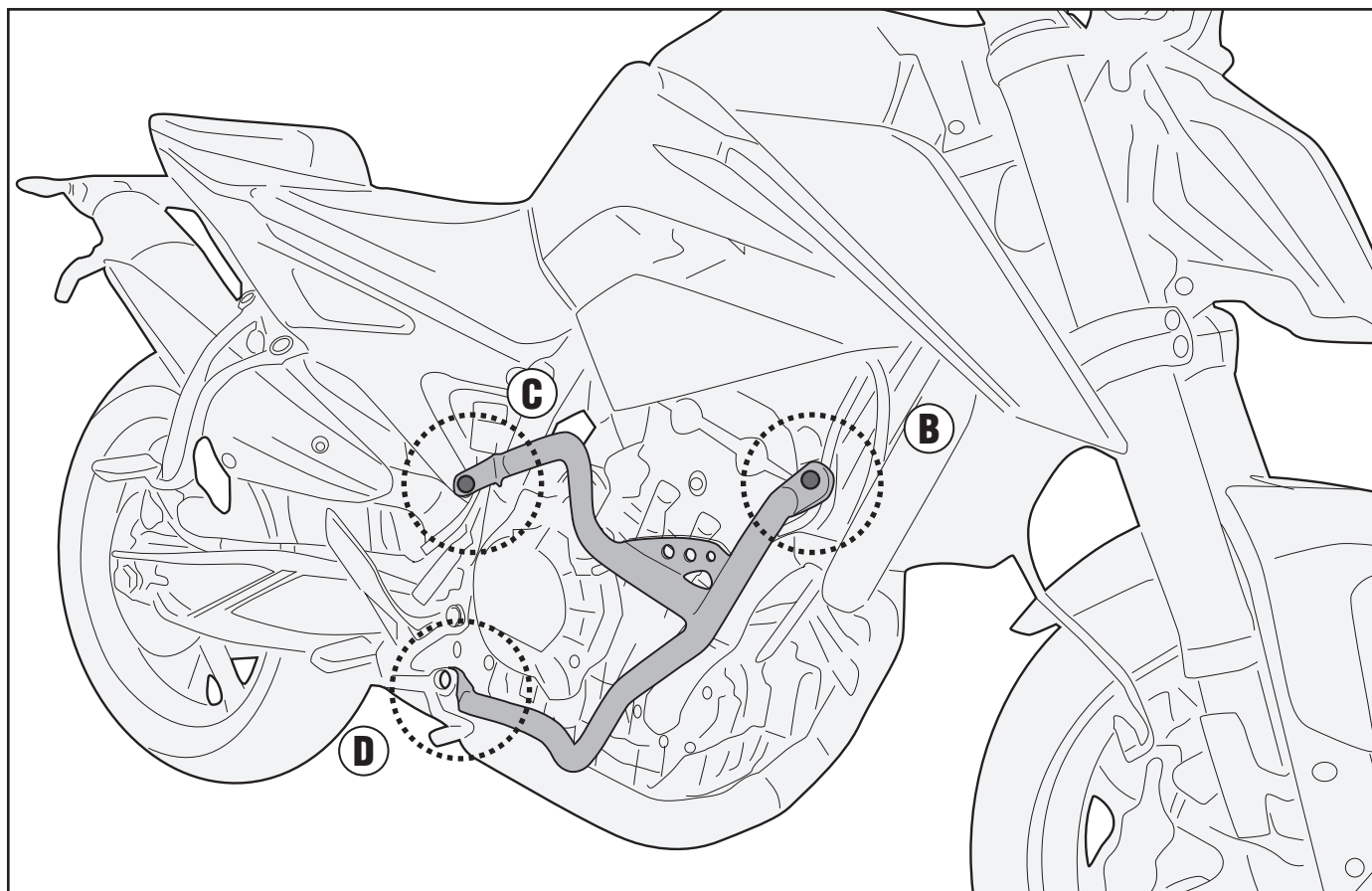
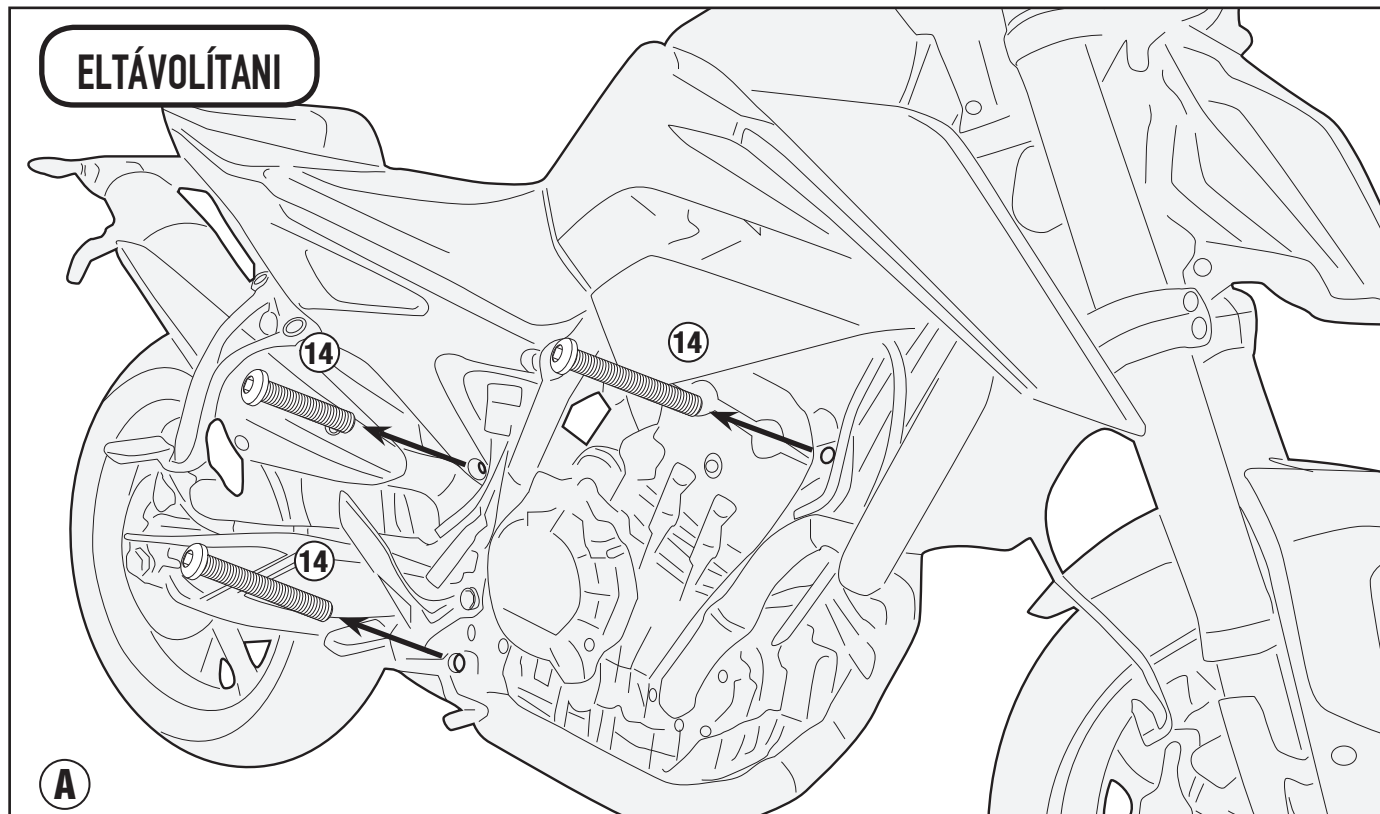

TN7708 - KN7708

Specialis Bukóscő

KTM DUKE 790 (2018)

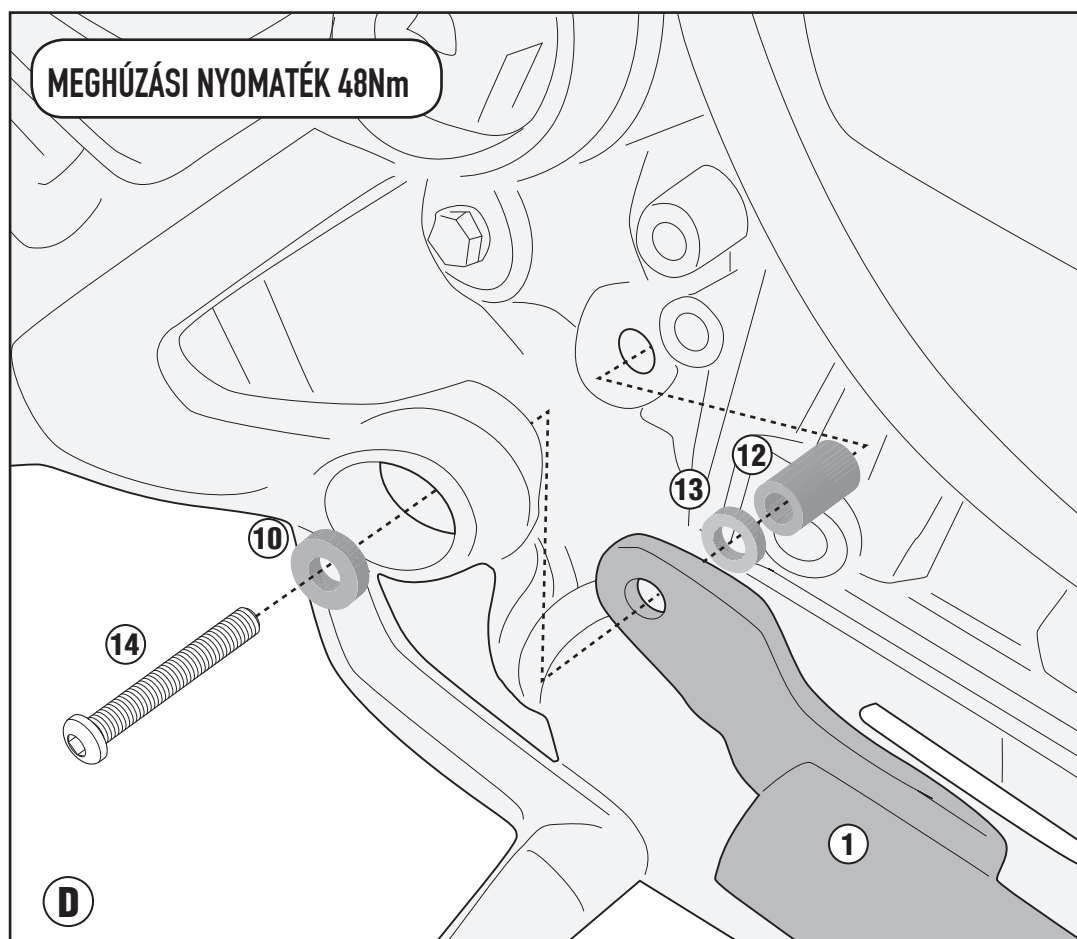
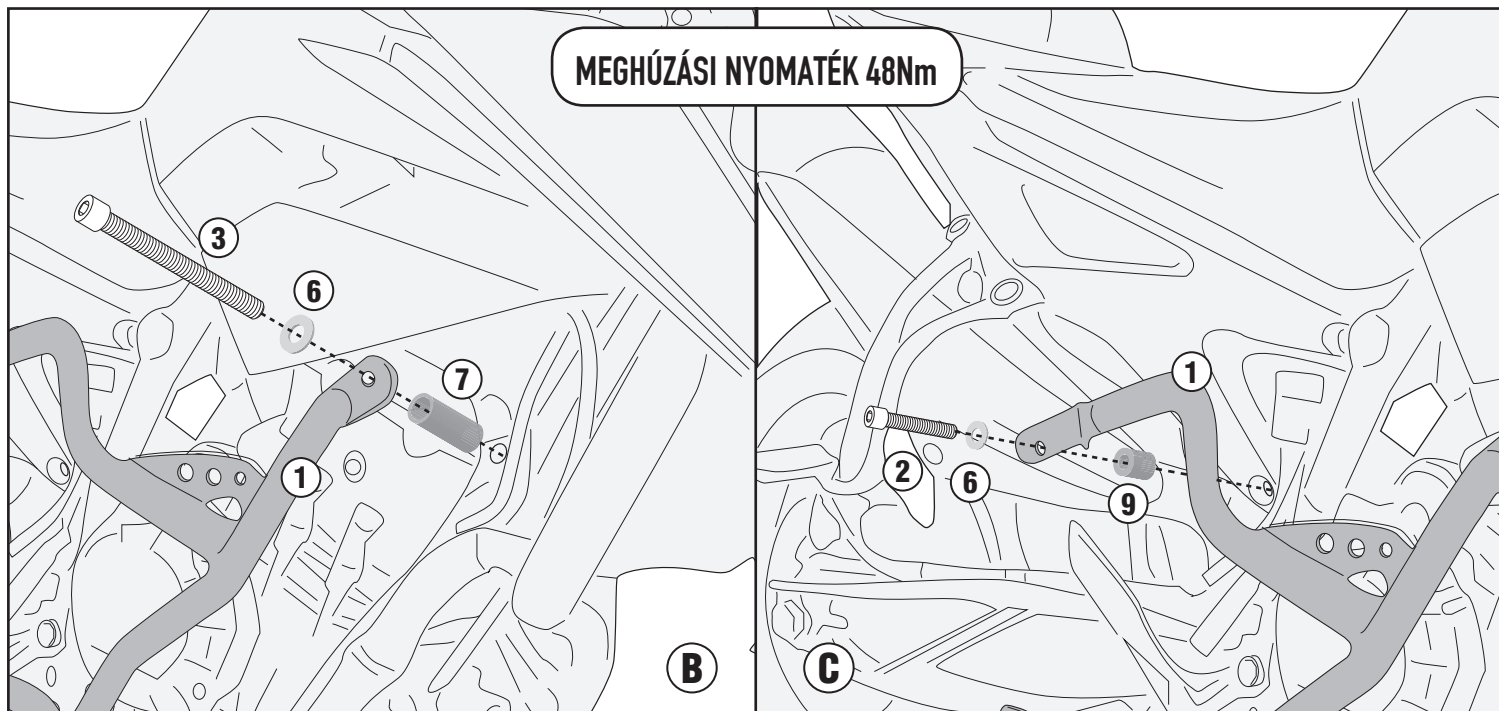

TN7708 - KN7708

Specialis Bukóscő

KTM DUKE 790 (2018)

Bal oldal

ELTÁVOLÍTANI

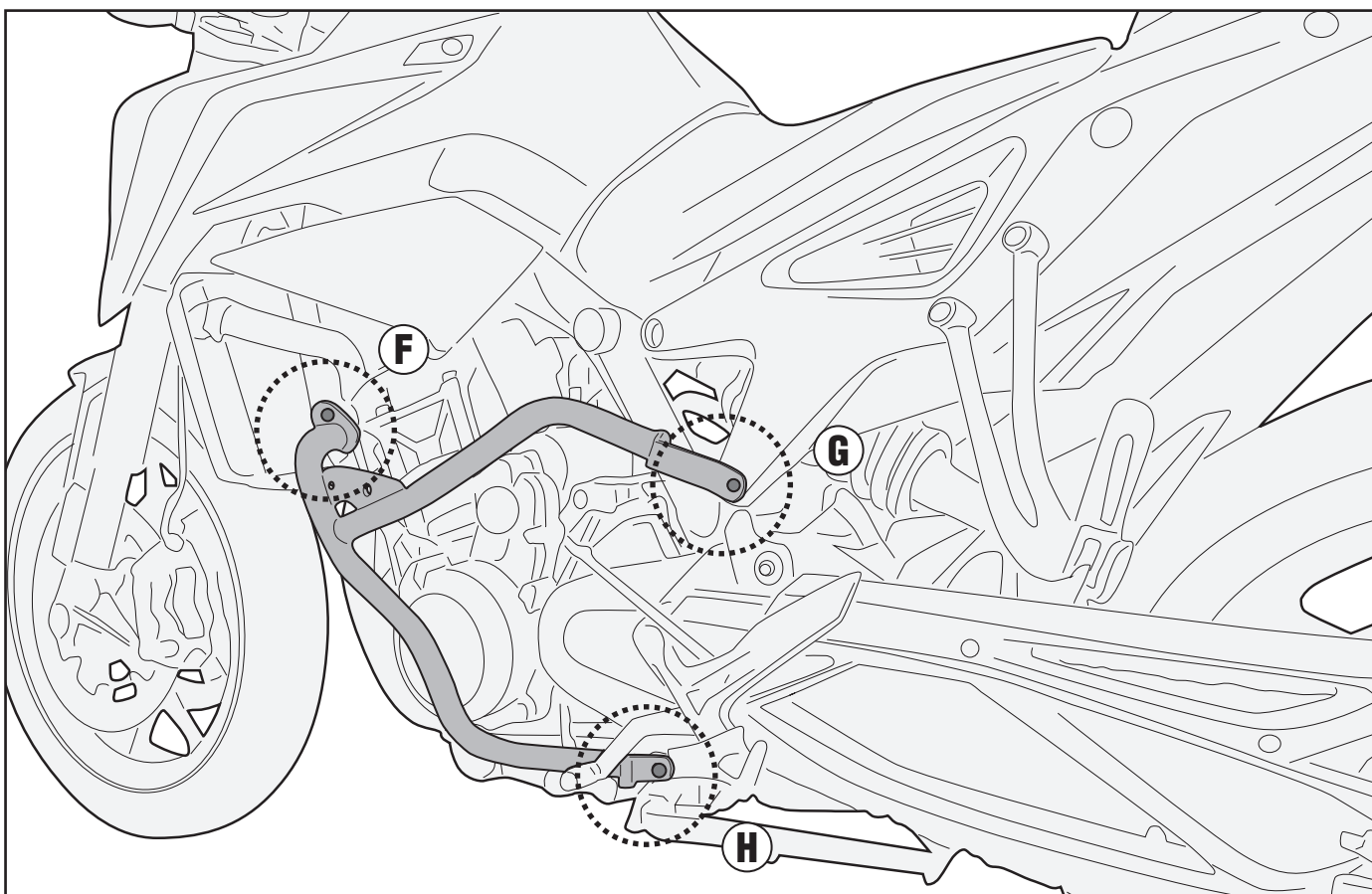
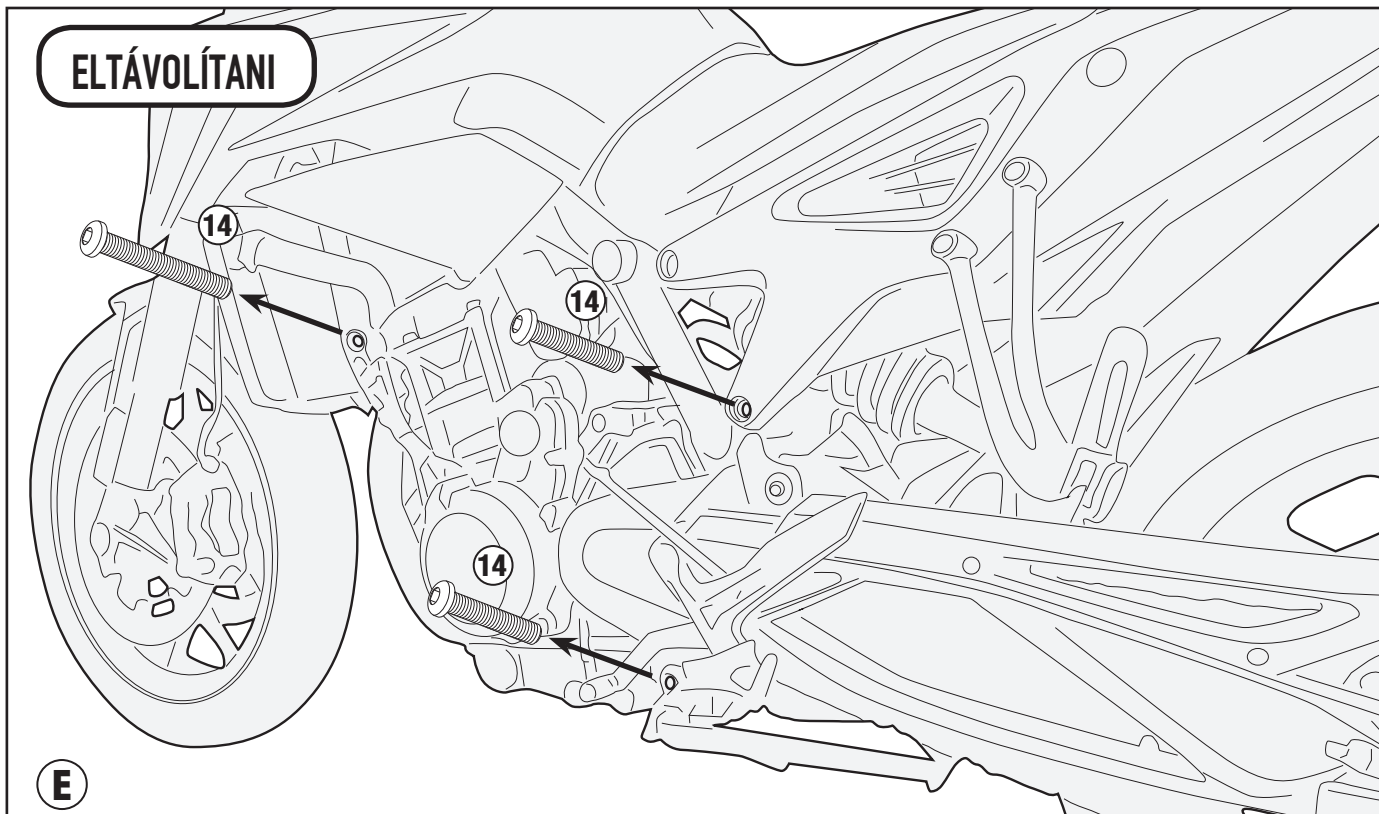

TN7708 - KN7708

Specialis Bukóscő

KTM DUKE 790 (2018)

